

# IN01 Series

## Commercial Touch Display

### User Guide

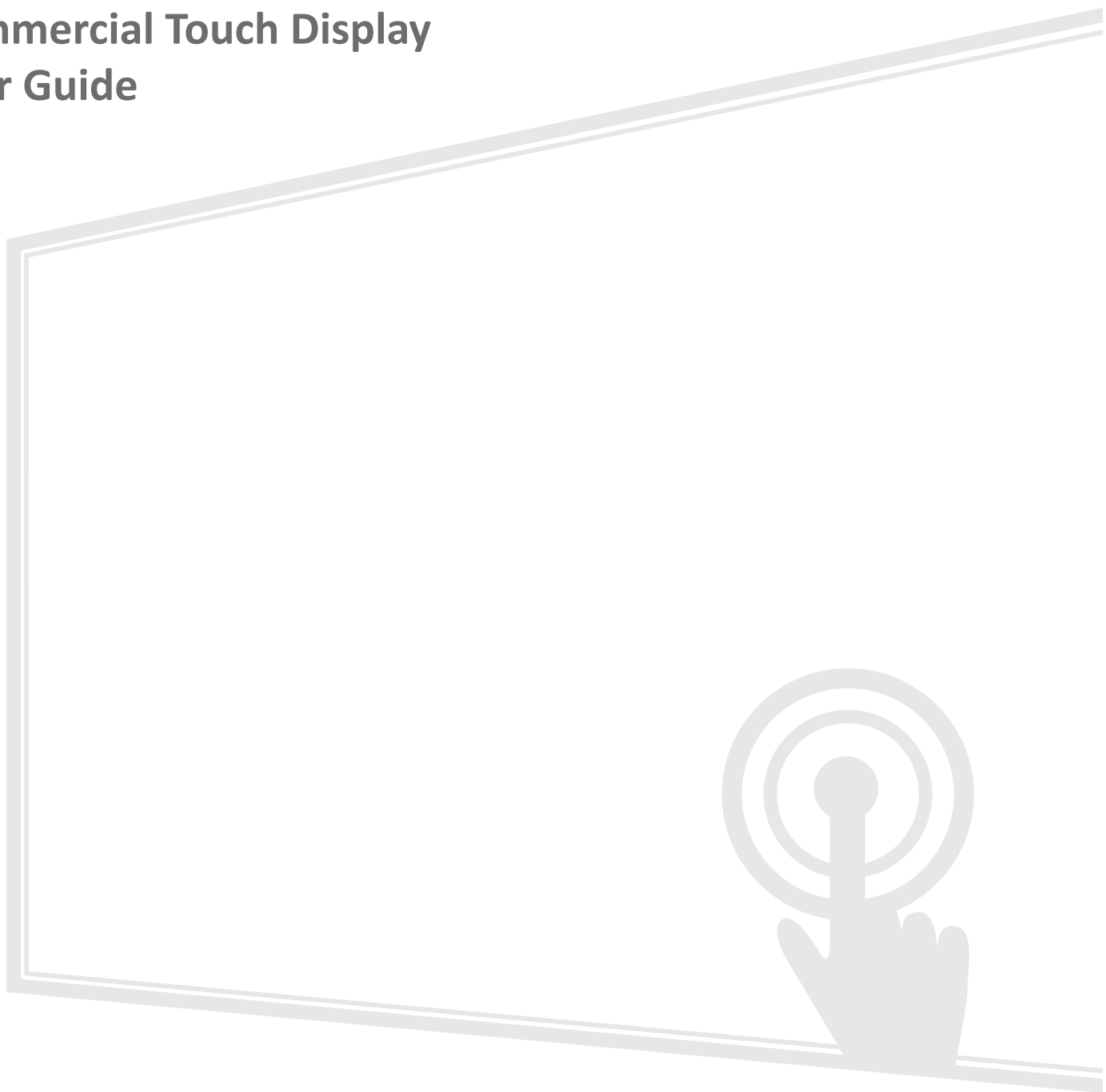

**IMPORTANT:** Please read this User Guide to obtain important information on installing and using your product in a safe manner, as well as registering your product for future service. Warranty information contained in this User Guide will describe your limited coverage from ViewSonic® Corporation, which is also found on our web site at <http://www.viewsonic.com> in English, or in specific languages using the Regional selection box of our website.

Model No. VS20038 | VS20039  
P/N: IN6501 | IN6501-G | IN7501 | IN7501-G

## **Thank you for choosing ViewSonic®**

As a world-leading provider of visual solutions, ViewSonic® is dedicated to exceeding the world's expectations for technological evolution, innovation, and simplicity. At ViewSonic®, we believe that our products have the potential to make a positive impact in the world, and we are confident that the ViewSonic® product you have chosen will serve you well.

Once again, thank you for choosing ViewSonic®!

# Safety Precautions

Please read the following **Safety Precautions** before you start using the device.

- Keep this user guide in a safe place for later reference.
- Read all warnings and follow all instructions.
- Do not use the device near water. To reduce the risk of fire or electric shock, do not expose the device to moisture.
- Never remove the rear cover. This display contains high-voltage parts. You may be seriously injured if you touch them.
- Avoid exposing the device to direct sunlight or other sources of sustained heat.
- Do not install near any heat sources such as radiators, heat registers, stoves, or other devices (including amplifiers) that may increase the temperature of the device to dangerous levels.
- Use a soft, dry cloth to clean the external housing. For more information, refer to the "Maintenance" section.
- When moving the device, be careful not to drop or bump the device on anything.
- Do not place the device on an uneven or unstable surface. The device may fall over resulting in an injury or a malfunction.
- Do not place any heavy objects on the device or connection cables.
- If smoke, an abnormal noise, or a strange odor is present, immediately turn the device off and call your dealer or ViewSonic®. It is dangerous to continue using the device.
- The device is a monitor with an LED backlight intended for general office use.
- Do not attempt to circumvent the safety provisions of the polarized or grounding-type plug. A polarized plug has two blades with one wider than the other. A grounding-type plug has two blades and a third grounding prong. The wide blade and the third prong are provided for your safety. If the plug does not fit into your outlet, obtain an adapter and do not attempt to force the plug into the outlet.
- When connecting to a power outlet, DO NOT remove the grounding prong. Please ensure grounding prongs are NEVER REMOVED.
- Protect the power cord from being treaded upon or pinched, particularly at the plug, and at the point where it emerges from the equipment. Ensure that the power outlet is located near the equipment so that it is easily accessible.

- Only use attachments/accessories specified by the manufacturer.
- When a cart is used, use with caution when moving the cart/equipment combination to avoid injury from tipping over.
- Disconnect the power plug from the AC outlet if the device is not being used for a long period of time.
- Place the device in a well-ventilated area. Do not place anything on the device that prevents heat dissipation.

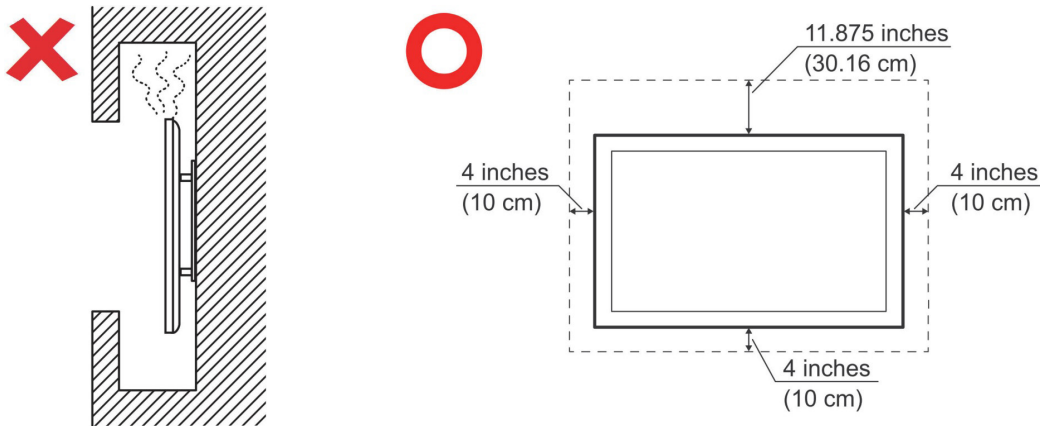

- Refer all servicing to qualified service personnel. Service will be required when the unit has been damaged in any way, such as:
  - » if the power supply cord or plug is damaged
  - » if liquid is spilled onto or objects fall in the unit
  - » if the unit is exposed to moisture
  - » if the unit does not operate normally or has been dropped

# Contents

<b>Safety Precautions.....</b>	<b>3</b>
<b>Introduction .....</b>	<b>10</b>
Package Contents .....	10
Wall Mount Kit Specifications (VESA) .....	11
Product Overview - IN6501 .....	12
Front View .....	12
Rear View .....	12
Control Panel and Front I/O - IN6501.....	13
Product Overview - IN7501 .....	14
Front View .....	14
Rear View .....	14
Control Panel and Front I/O - IN7501.....	15
I/O Panels - IN6501/IN7501.....	16
Rear I/O .....	16
Side I/O.....	17
Remote Control .....	18
Using Gestures .....	21
<b>Making Connections.....</b>	<b>23</b>
Connecting to Power .....	23
Connecting to External Devices and Enabling Touch.....	24
HDMI Connection .....	24
VGA Connection .....	24
RS-232 Connection .....	25
USB Connection .....	26
USB Type A .....	26
USB Type C .....	26
Network Connection.....	27
Media Connection .....	28
Audio Connection .....	29
Audio In .....	29
Audio Out .....	29
SPDIF Connection .....	29
Video Output Connection (HDMI Out) .....	30
Optional Connections .....	31
Slot-in PC (OPS Slot) Installation .....	31

<b>Using the Display.....</b>	<b>32</b>
Turning On/Off the Display.....	32
Initial Launch Setup .....	33
Home Screen .....	36
Negative One Screen .....	37
Status Bar .....	38
Toolbar .....	39
Comments .....	41
Control Panel .....	43
Shortcut Tools .....	43
Sidebar .....	46
Applications.....	47
Input Source .....	49
Compass .....	50
Low Blue Light Filter and Eye Health.....	51

<b>System Settings .....</b>	<b>53</b>
Network.....	53
Wi-Fi .....	54
Ethernet .....	55
Hotspot.....	56
Bluetooth .....	57
General .....	58
Custom .....	59
Sound .....	61
Display .....	62
Compass .....	63
Gesture Interaction .....	65
Screen Record Settings.....	66
Channel.....	67
Channel Image.....	68
More Settings .....	69
System .....	70
Date & Time .....	71
Language & Input Method .....	72
Power Status .....	73
System Update .....	74
System Security .....	75
About.....	77

<b>Pre-installed Applications and Settings.....</b>	<b>78</b>
EShare.....	78
Key Features.....	79
Device Requirements.....	79
Network Requirements.....	80
Bandwidth Requirements.....	80
EShare Application.....	81
Download the EShare Application.....	81
For Android/iOS Devices.....	82
For Windows/macOS/ChromeOS/Ubuntu Devices.....	88
EShare Pro Receiver.....	93
Key Features.....	93
Settings.....	94
Multiple Screens.....	95
Display Group.....	97
Moderator Control Center.....	100
Casting without EShare.....	104
AirPlay.....	105
Miracast.....	107
Other Default Applications.....	108
Browser.....	108
Easy Upload.....	109
File Manager.....	110
Gallery.....	111
Hardware Detection.....	112
Screen Record.....	113
Screenshot.....	114
Timer.....	115
VoteKit.....	116
Welcome.....	117
Whiteboard.....	118

<b>RS-232 Protocol</b> .....	<b>124</b>
Description .....	124
RS-232 Hardware Specification .....	124
LAN Hardware Specification.....	125
RS-232 Communication Setting.....	125
LAN Communication Setting .....	125
Command Message Reference.....	125
Protocol .....	126
Set-Function Listing.....	126
Set-Function Table (Basic Function).....	127
<b>Appendix</b> .....	<b>138</b>
Specifications.....	138
Resolution and Timings .....	140
HDMI .....	140
VGA .....	140
Troubleshooting .....	141
Maintenance.....	143
General Precautions.....	143
Cleaning the Screen.....	143
Cleaning the Case .....	143
<b>Regulatory and Service Information</b> .....	<b>144</b>
Compliance Information.....	144
Declaration of RoHS2 Compliance.....	144
Indian Restriction of Hazardous Substances .....	145
Product Disposal at End of Product Life .....	145
Copyright Information .....	146
Customer Service .....	147
Limited Warranty .....	148
Mexico Limited Warranty.....	151

# Introduction

## Package Contents



HDMI cable



5m Touch USB Cable (for IN6501)  
3m Touch USB Cable (for IN7501)

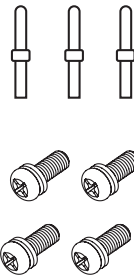
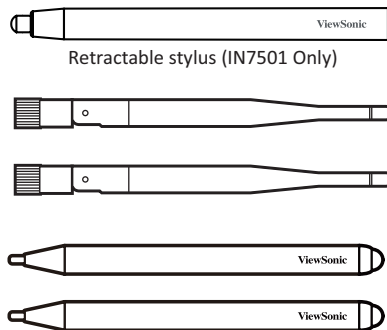
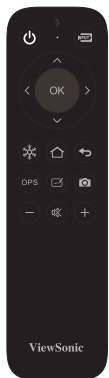
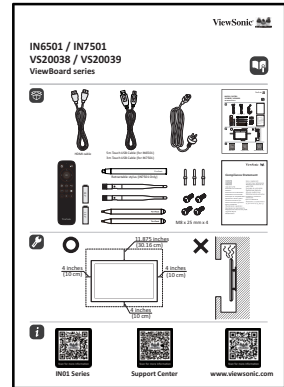

M8 x 25 mm x 4

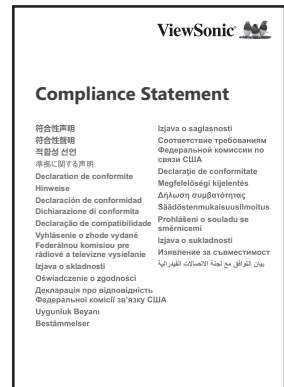

- 1 x HDMI Cable (3 m)
- 1 x Remote Control
- 1 x USB Touch Cable (5 m)<sup>1</sup>
- 2 x Touch Pen
- 3 x Touch Pen Tip
- 4 x Screws
- Compliance Statement
- Power Cable
- 2 x Batteries
- 1 x USB Touch Cable (3 m)<sup>2</sup>
- 1 x Retractable Stylus<sup>2</sup>
- 2 x Wi-Fi Dual Band Antenna
- Quick Start Guide

**NOTE:** The cables included in your package may vary depending on your country. Please contact your local reseller for more information.

1 - For IN6501

2 - For IN7501

## Wall Mount Kit Specifications (VESA)

**NOTE:** Please follow the instructions in the wall mount installation guide to install your wall mount. If attaching to other building materials, please contact your nearest dealer.

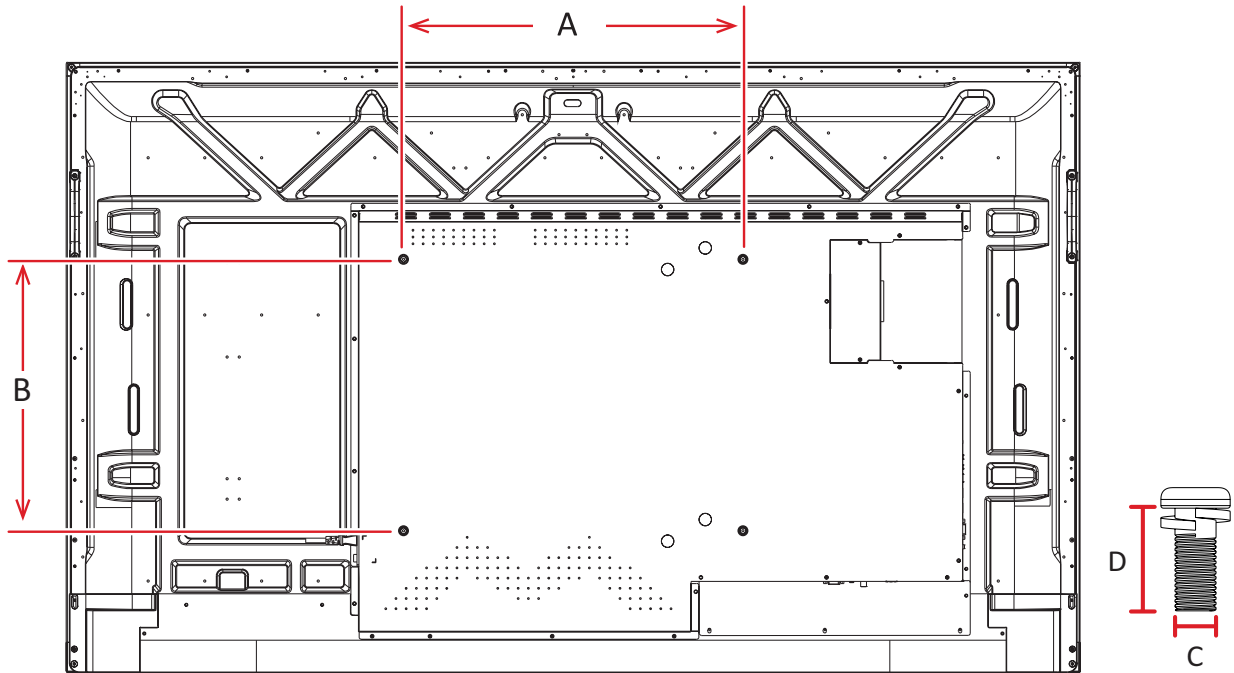

Model	VESA Spec. (A x B)	Standard Screw (C x D)	Quantity
IN6501	500 x 400 mm	M8 x 25 mm	4
IN7501	600 x 400 mm	M8 x 25 mm	4

**NOTE:** Do not use screws that are longer than the standard dimension, as they may cause damage to the inside of the display.

# Product Overview - IN6501

## Front View

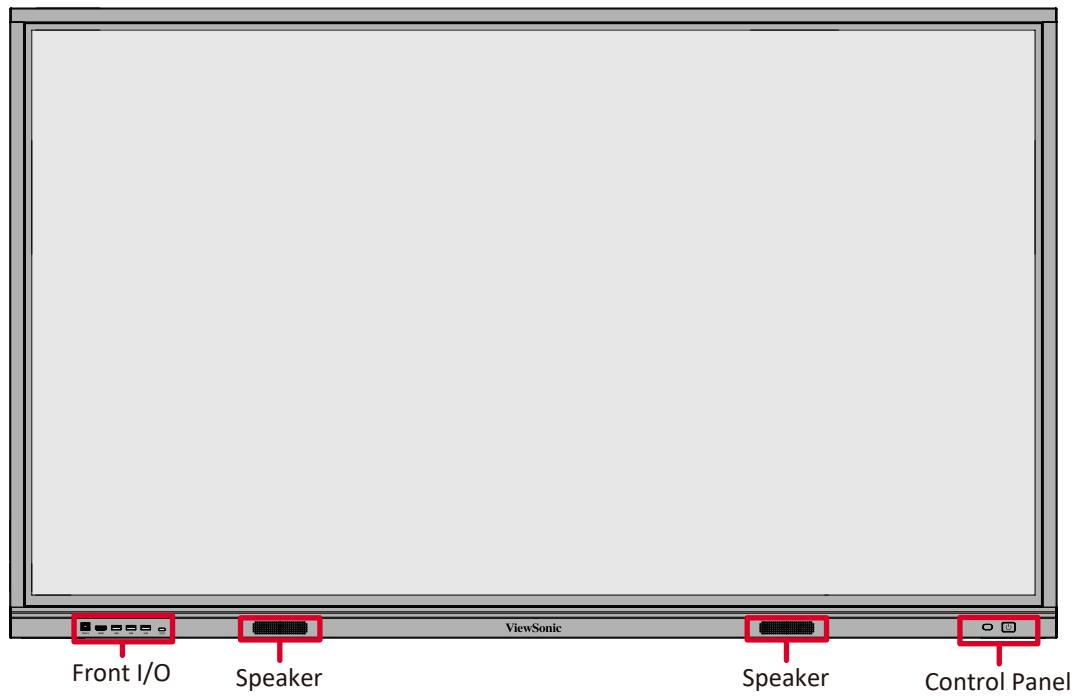

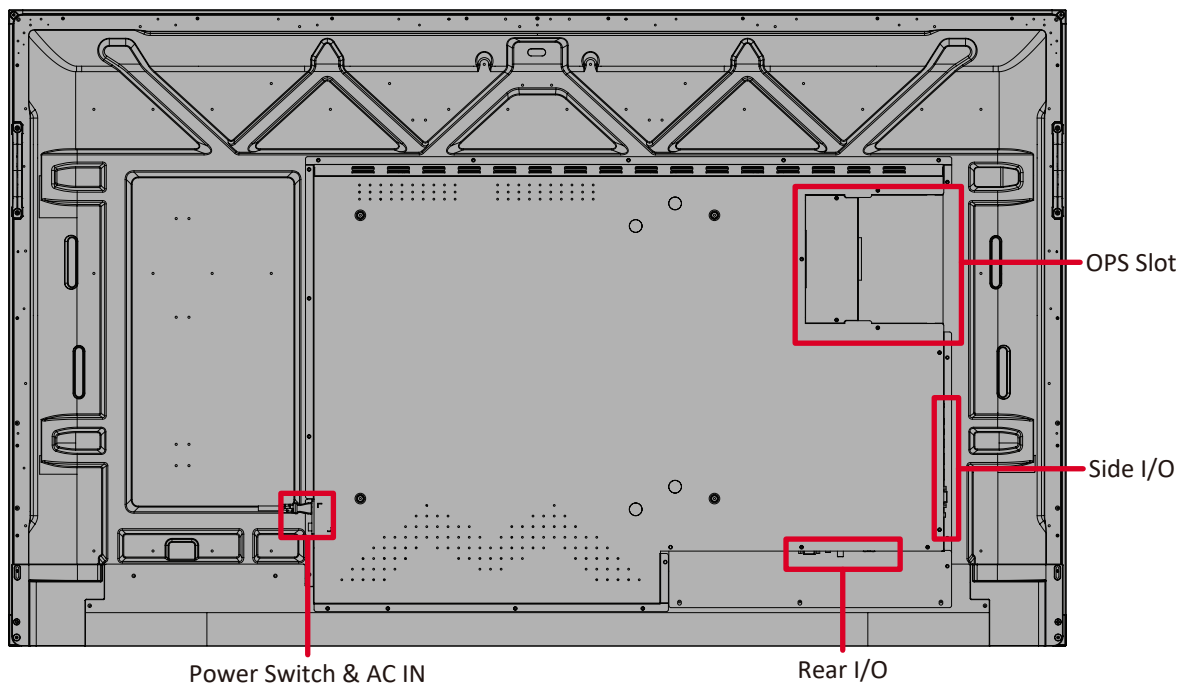

## Rear View

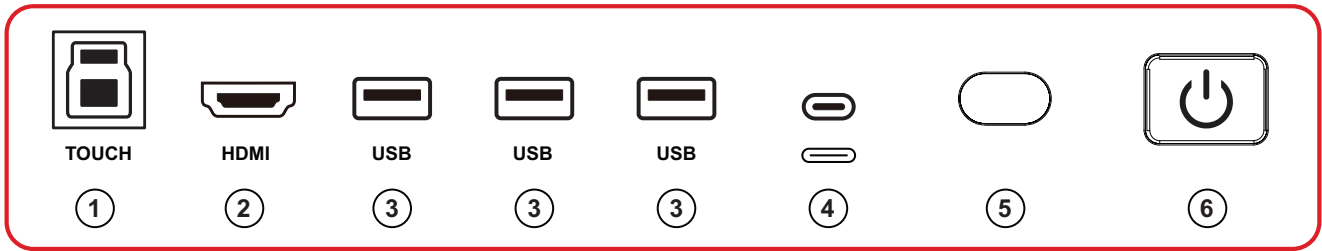

## Control Panel and Front I/O - IN6501



Number	Item	Description
1	TOUCH	<ul style="list-style-type: none"> <li>• USB Type B.</li> <li>• USB 2.0 standard.</li> <li>• Touch signal output to external computer.</li> <li>• After connection (with an external computer), the device connected to the <b>USB</b> port can directly be used by the external computer.</li> <li>• Pairs with the front <b>HDMI</b> port next to it.</li> </ul>
2	HDMI	<ul style="list-style-type: none"> <li>• HDMI input.</li> <li>• Connect to a computer with HDMI output, set-top box, or other video device.</li> <li>• Supports 4K display; HDMI 2.0.</li> </ul>
3	USB	<ul style="list-style-type: none"> <li>• USB Type A.</li> <li>• USB 3.0 standard.</li> <li>• Connect USB devices such as hard disks, keyboard, mouse, etc.</li> </ul>
4		<ul style="list-style-type: none"> <li>• USB Type C.</li> <li>• USB 2.0 standard.</li> <li>• Connect USB devices such as hard disks, keyboard, mouse, etc.</li> </ul>
5		Remote control receiver.
6		<ul style="list-style-type: none"> <li>• Power indicator light.</li> <li>• Press to turn on the display.</li> <li>• Once on, press again to turn on or off the backlight only.</li> <li>• Once on, press and hold to turn off the display.</li> </ul>

# Product Overview - IN7501

## Front View

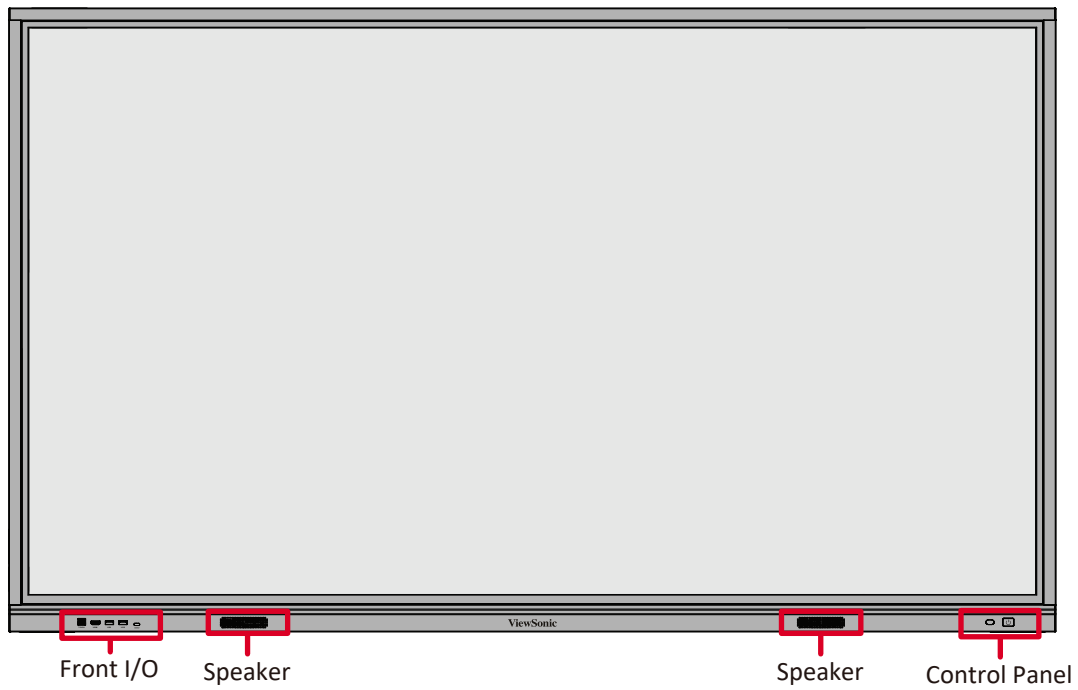

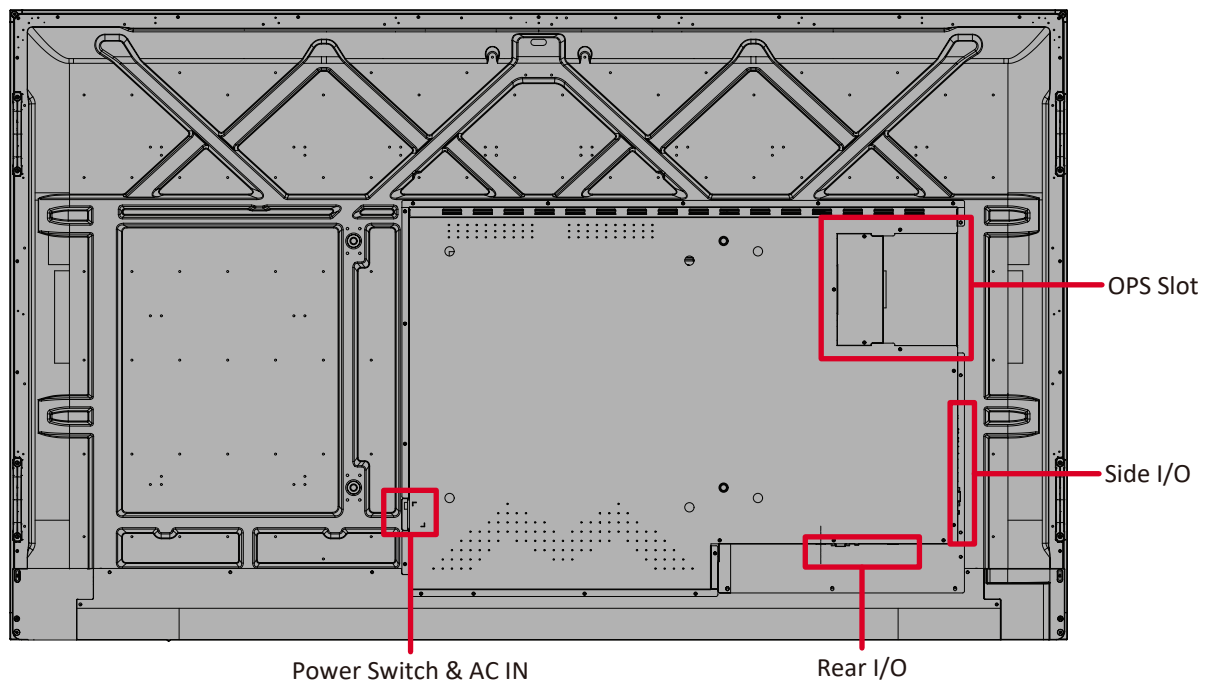

## Rear View

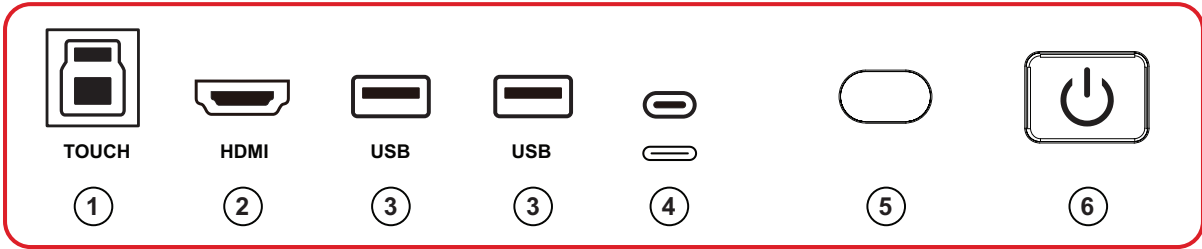

## Control Panel and Front I/O - IN7501



Number	Item	Description
1	TOUCH	<ul style="list-style-type: none"> <li>• USB Type B.</li> <li>• USB 2.0 standard.</li> <li>• Touch signal output to external computer.</li> <li>• After connection (with an external computer), the device connected to the <b>USB</b> port can directly be used by the external computer.</li> <li>• Pairs with the front <b>HDMI</b> port next to it.</li> </ul>
2	HDMI	<ul style="list-style-type: none"> <li>• HDMI input.</li> <li>• Connect to a computer with HDMI output, set-top box, or other video device.</li> <li>• Supports 4K display; HDMI 2.0.</li> </ul>
3	USB	<ul style="list-style-type: none"> <li>• USB Type A.</li> <li>• USB 3.0 standard.</li> <li>• Connect USB devices such as hard disks, keyboard, mouse, etc.</li> </ul>
4		<ul style="list-style-type: none"> <li>• USB Type C.</li> <li>• USB 2.0 standard.</li> <li>• Connect USB devices such as hard disks, keyboard, mouse, etc.</li> </ul>
5		Remote control receiver.
6		<ul style="list-style-type: none"> <li>• Power indicator light.</li> <li>• Press to turn on the display.</li> <li>• Once on, press again to turn on or off the backlight only.</li> <li>• Once on, press and hold to turn off the display.</li> </ul>

# I/O Panels - IN6501/IN7501

## Rear I/O

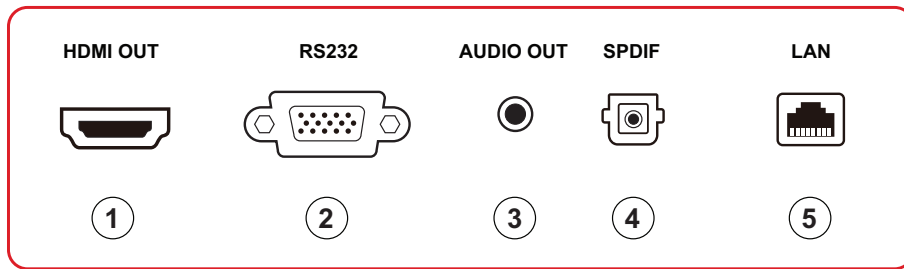

Number	Item	Description
1	<b>HDMI OUT</b>	<ul style="list-style-type: none"><li>• HDMI output.</li><li>• Extend content out to another display device.</li><li>• Supports 4K display; HDMI 2.0.</li></ul>
2	<b>RS232</b>	Serial interface; used for mutual transfer of data between devices
3	<b>AUDIO OUT</b>	Audio output to an external speaker/headset
4	<b>SPDIF</b>	Multichannel sound via optical signals.
5	<b>LAN</b>	Standard RJ45 (10M/100M) Internet connection interface.

## Side I/O

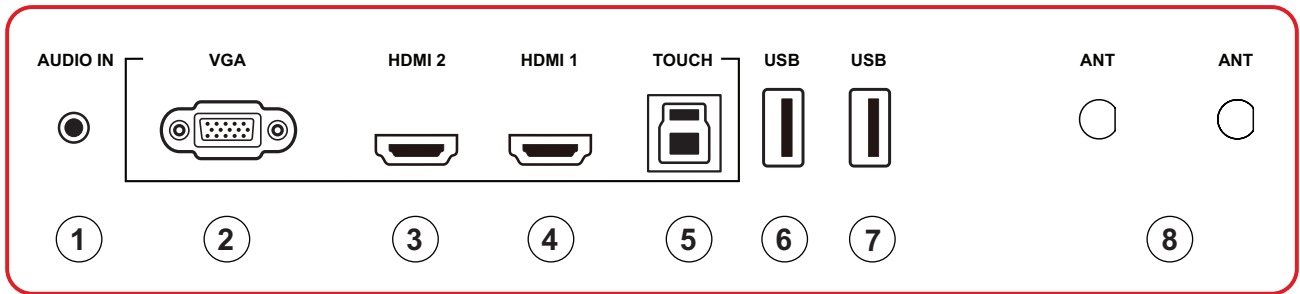

Number	Item	Description
1	AUDIO IN	External computer audio input.
2	VGA	<ul style="list-style-type: none"> <li>VGA signal input</li> <li>Connect to a PC with VGA output, set-top box, or other video device.</li> </ul>
3	HDMI 2	<ul style="list-style-type: none"> <li>HDMI input.</li> <li>Connect to a computer with HDMI output, set-top box, or other video device.</li> <li>Supports 4K display; HDMI 2.0; CEC &amp; ARC.</li> </ul>
4	HDMI 1	<ul style="list-style-type: none"> <li>HDMI input.</li> <li>Connect to a computer with HDMI output, set-top box, or other video device.</li> <li>Supports 4K display; HDMI 2.0; CEC.</li> </ul>
5	TOUCH	<ul style="list-style-type: none"> <li>USB Type B.</li> <li>USB 2.0 standard.</li> <li>Touch signal output to external computer.</li> <li>After connection (with an external computer), the device connected to the <b>USB</b> port can directly be used by the external computer.</li> <li>Pairs with the <b>HDMI 1</b>, <b>HDMI 2</b>, and <b>VGA</b> port.</li> </ul>
6	USB	<ul style="list-style-type: none"> <li>USB Type A.</li> <li>USB 3.0 standard.</li> <li>Connect USB devices such as hard disks, keyboard, mouse, etc.</li> </ul>
7	USB	<ul style="list-style-type: none"> <li>USB Type A.</li> <li>USB 2.0 standard.</li> <li>Only supports Android.</li> </ul>
8	ANT	<ul style="list-style-type: none"> <li>Antenna interface.</li> <li>For Wi-Fi and hotspot.</li> </ul>

## Remote Control

Number	Description
1	Power on/off
2	Input source selection
3	Scroll up, down, left, right
4	Confirm selection
5	Freeze screen
6	Go to the Home screen
7	Return to previous
8	Switch to OPS
9	Launch the whiteboard
10	Take a screenshot
11	Decrease the volume
12	Mute/unmute
13	Increase the volume

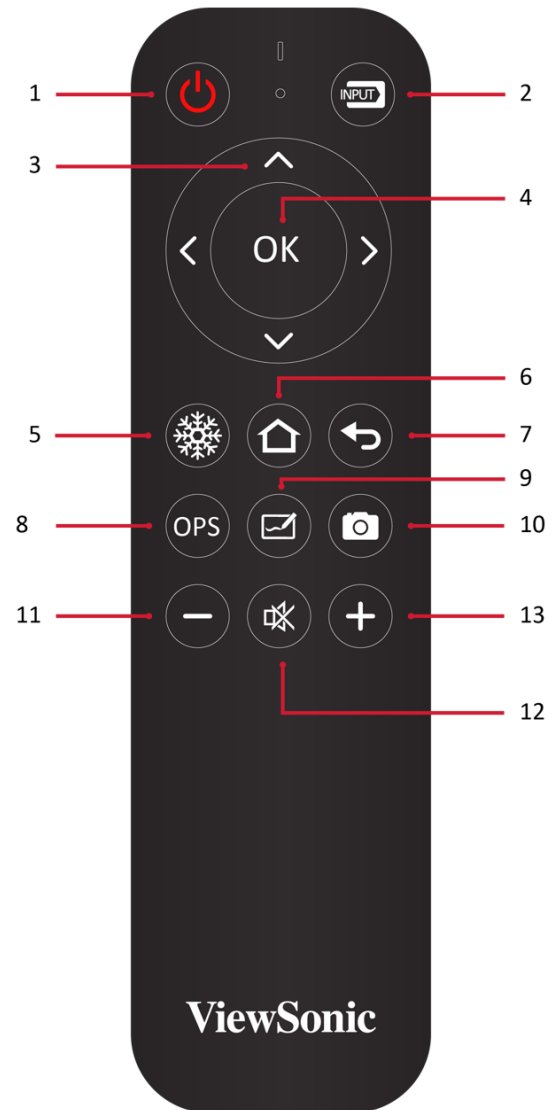

## Inserting Remote Control Batteries

To insert batteries into the remote control:

1. Remove the cover on the rear of the remote control.
2. Insert two “AAA” batteries, ensuring the “+” symbol on the battery matches the “+” on the battery post.
3. Replace the cover by aligning it with the slot on the remote control and snapping the latch shut.

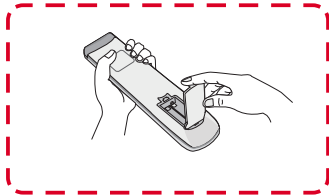

(1)

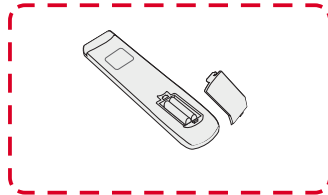

(2)

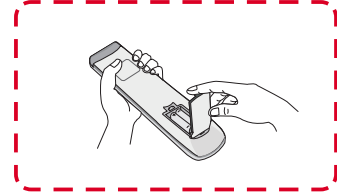

(3)

**WARNING:** There is a risk of explosion if batteries are replaced with the incorrect type.

### NOTE:

- It is recommended that you do not mix battery types.
- Always dispose of old batteries in an environmentally friendly way. Contact your local government for more information on how to dispose of batteries safely.

## Remote Control Receiver Range

The working range of the remote control is shown here. It has an effective range of 8 meters, 30° degrees left and right. Please make sure there is nothing obstructing the remote control's signal to the receiver.

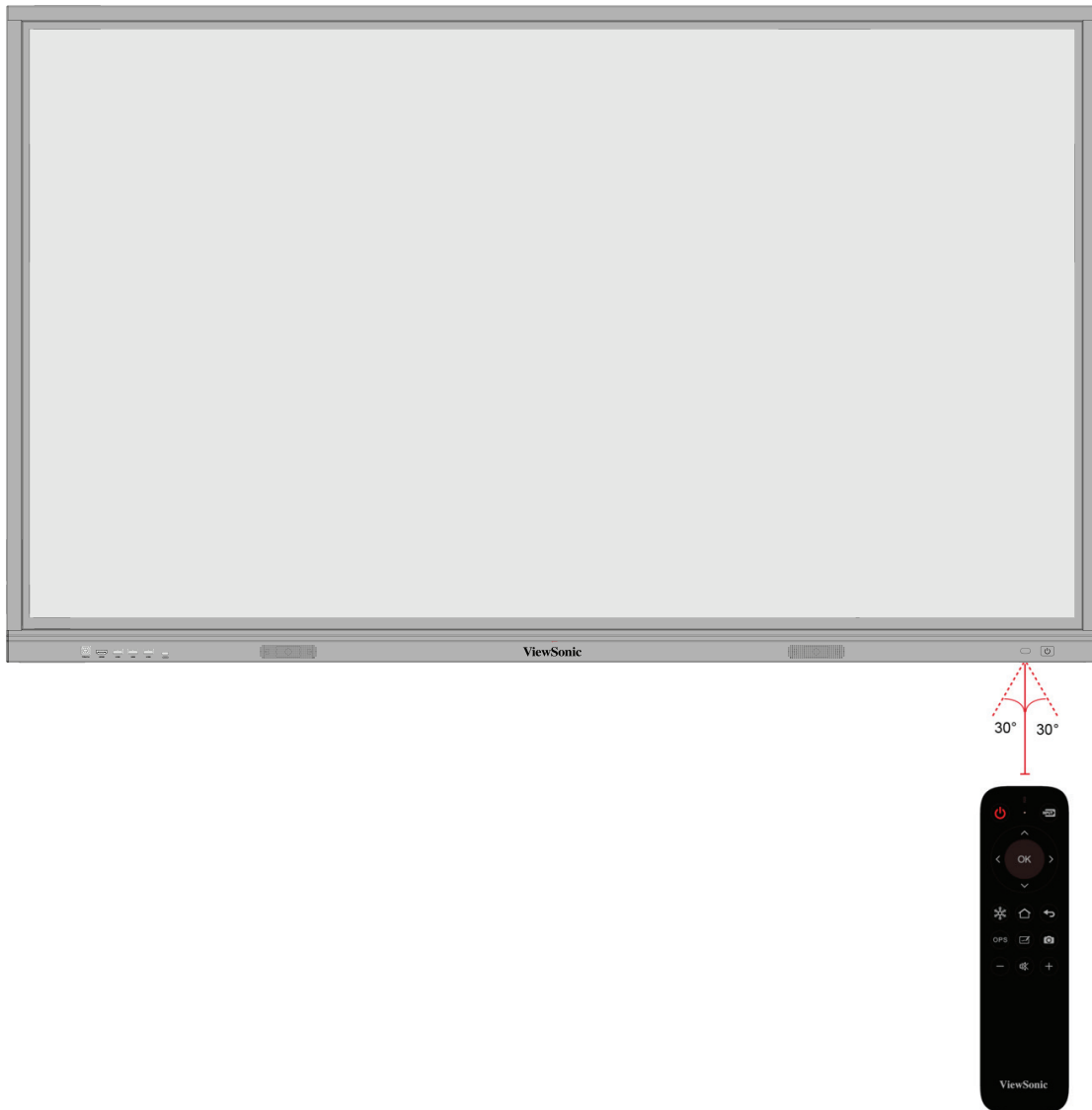

## Using Gestures

Touch gestures allow the user to use pre-determined commands without using a keyboard or mouse. Using gestures on the ViewBoard, the user can select/deselect objects, change the location of an object, access settings, erase digital ink, and much more.

### Select and Deselect an Object (Clicking)

Press and release the ViewBoard to select/deselect options or objects. This is like a single, standard left mouse click.

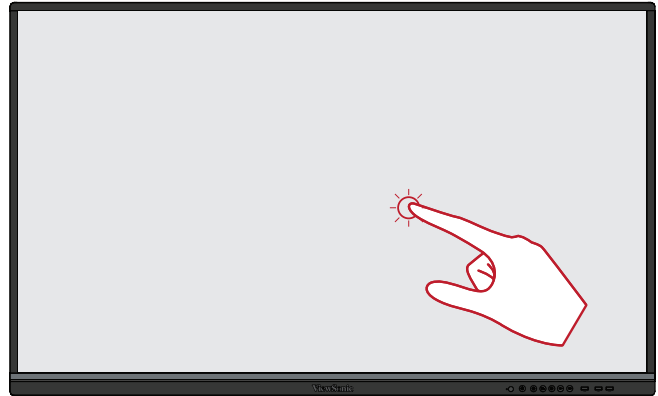

### Display Menu Options (Right-Clicking)

Press and hold the ViewBoard with your finger. This is like a single, standard right mouse click.

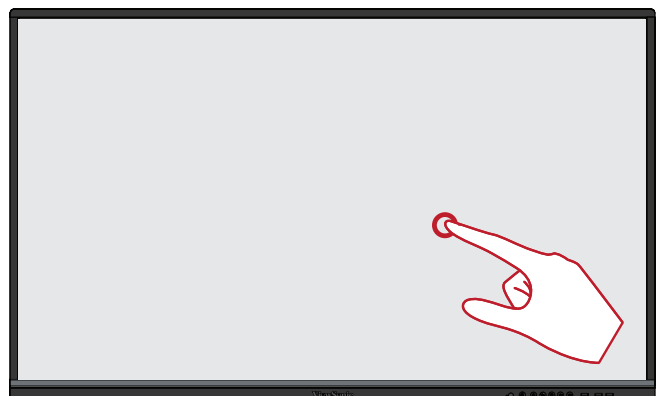

### Double-Clicking

Quickly press and release twice in the same location on the ViewBoard. This is like a double, standard left mouse click.

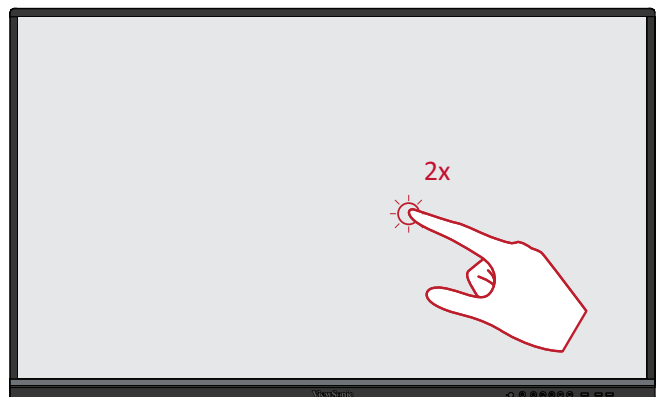

## Moving an Object

Press and hold the object on the ViewBoard and slowly drag it with your finger to your desired location.



## Erasing Digital Ink

Use your flattened hand, palm, or fist on the ViewBoard and move your hand across the area which you wish to erase.

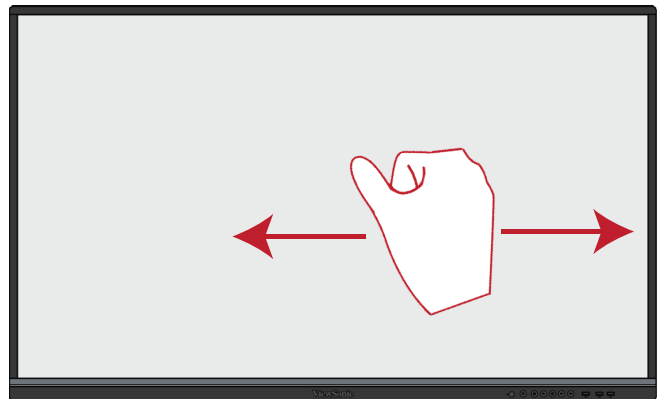

## Swipe Up for General Settings

Swipe up from the bottom of the ViewBoard to launch the General Settings.

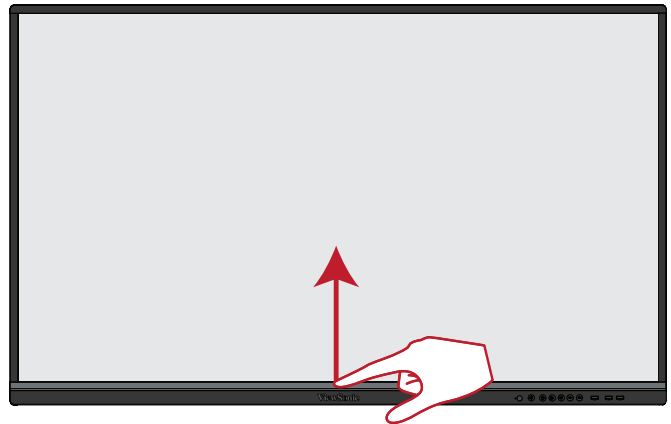

# Making Connections

## Connecting to Power

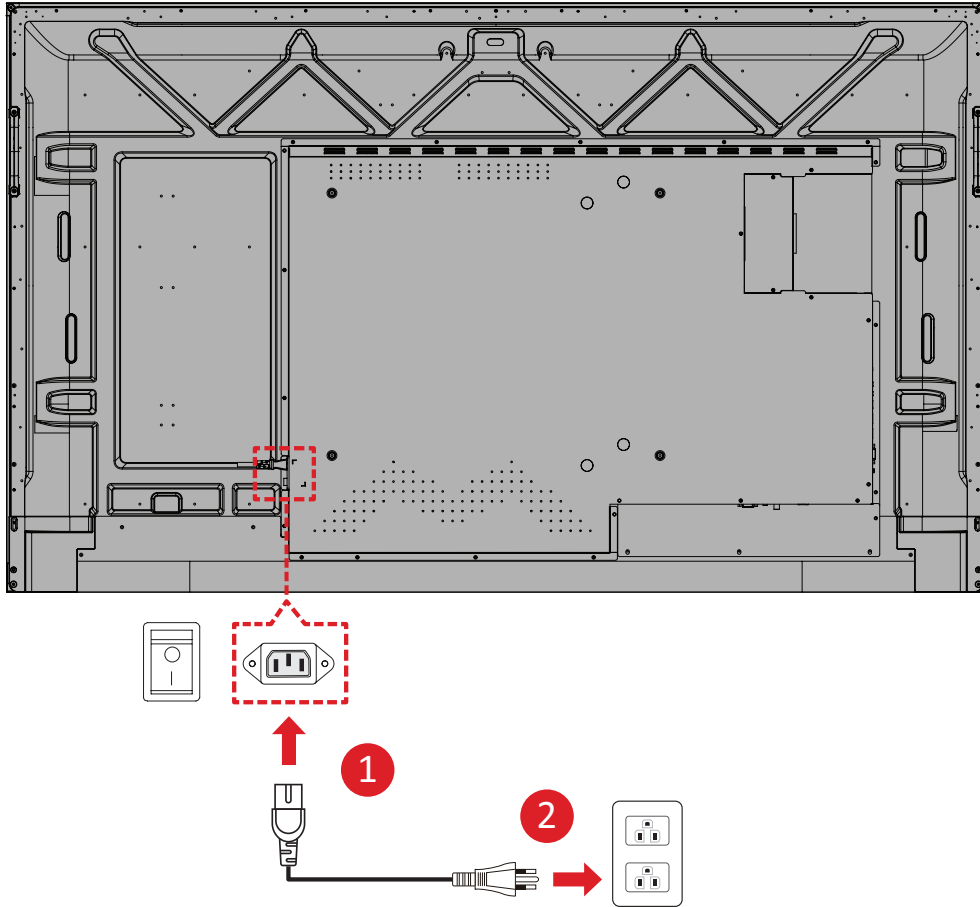

1. Connect the power cord to the AC IN jack at the rear of the display.
2. Plug the power cord plug into a power outlet.

# Connecting to External Devices and Enabling Touch

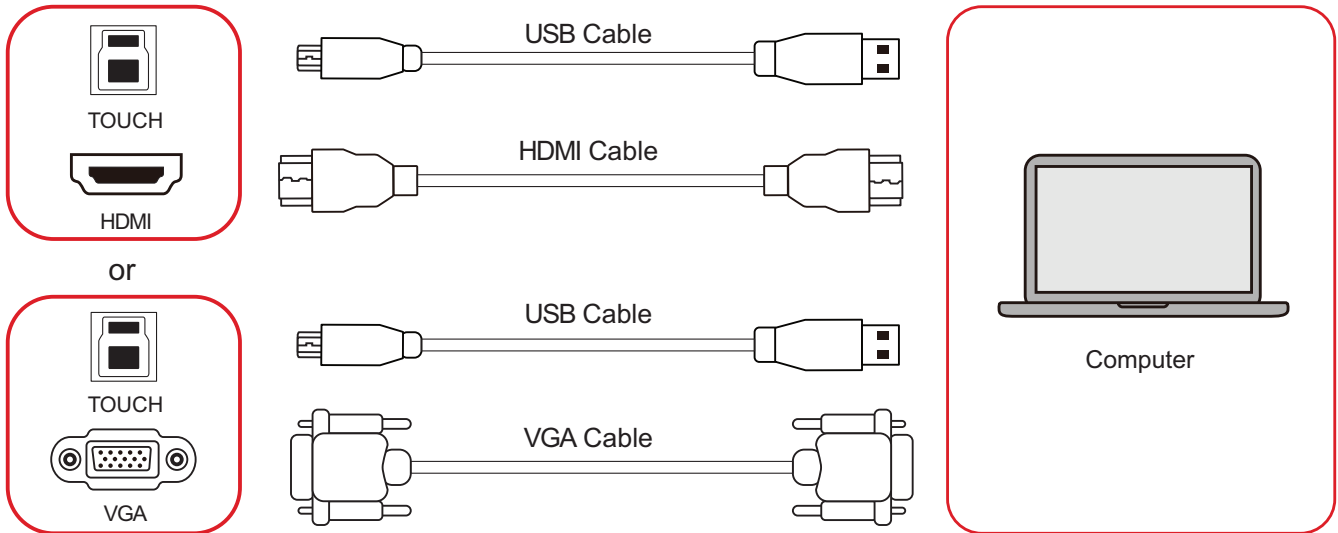

Your external device(s) can be connected in any of the following configurations:

## HDMI Connection

To connect via HDMI:

1. Connect an HDMI cable from your external device to the **HDMI/HDMI 1/HDMI 2** port on the display.
2. Connect a USB Type B to A to the external device from the appropriate **TOUCH** port of the display.

**NOTE:** The front I/O **TOUCH** port is for the front I/O **HDMI** port. The side I/O **TOUCH** port is for the **HDMI 1**, **HDMI 2**, and **VGA** ports.

## VGA Connection

To connect via VGA:

1. Connect a VGA cable from your external device to the **VGA** port on the display.
2. Connect a USB Type B to A to the external device from the **TOUCH** port of the display.

**NOTE:** The front I/O **TOUCH** port is for the front I/O **HDMI** port. The side I/O **TOUCH** port is for the **HDMI 1**, **HDMI 2**, and **VGA** ports.

## RS-232 Connection



When you use a RS-232 serial cable to connect the display to an external computer or control system, certain functions can be controlled remotely such as: power on and off, volume adjustment, input select, brightness, and more.

## USB Connection

Just like any PC, it is easy to connect various USB devices and other peripherals to the display.

### USB Type A

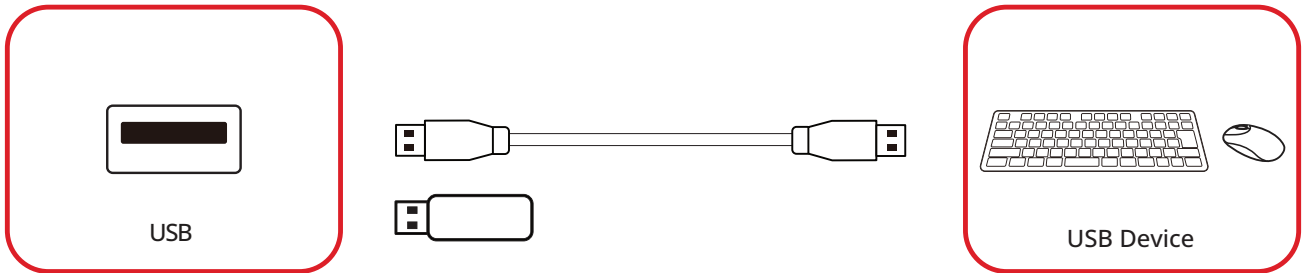

Plug the USB device or storage drive into a USB Type A port of the display.

### USB Type C

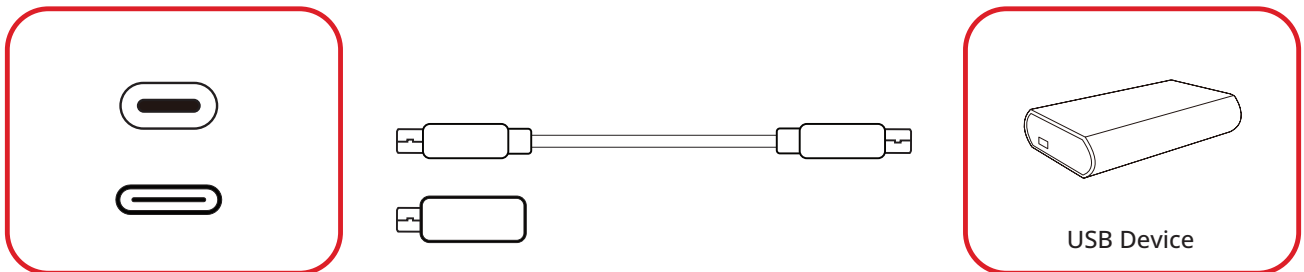

Plug the USB device or storage drive into the USB Type C port of the display.

## Network Connection



To connect to a local network, connect an Ethernet cable to your network, then connect the other end to a **LAN** port of the display.

## Media Connection

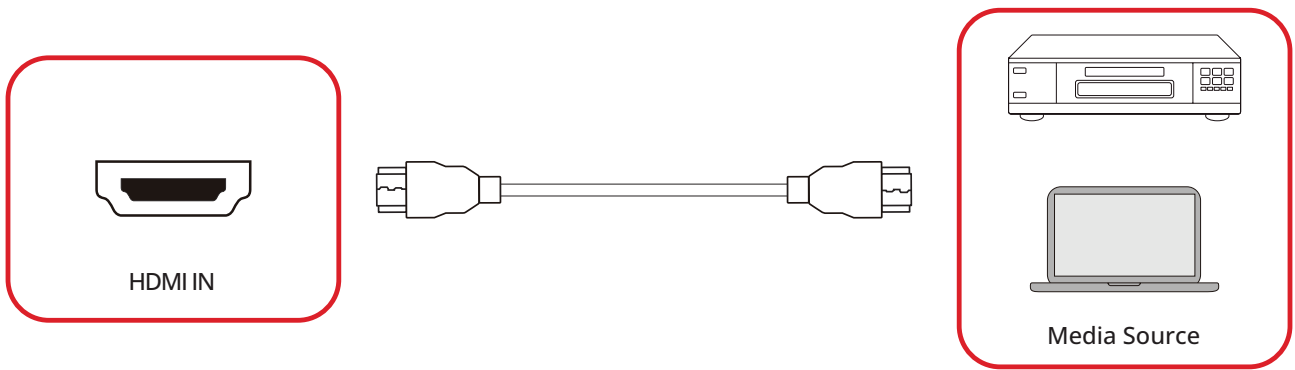

To connect to a media source:

1. Connect an HDMI cable to a **HDMI** port on the display and peripheral device.
2. Press the **INPUT** button on the remote control and switch to the HDMI input source.

## Audio Connection

The display supports **Audio In**, **Audio Out**, and **SPDIF**.

### Audio In

To play audio from your external device through the display's speakers, connect one end of an audio cable to your external device, and the other end to the display's **AUDIO IN** port.

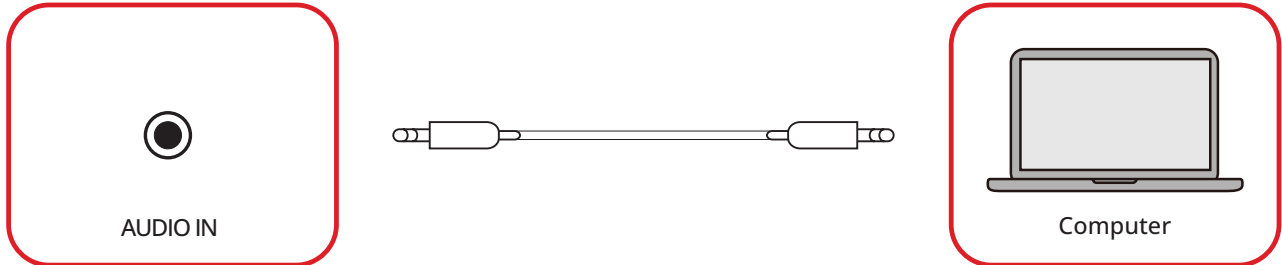

### Audio Out

To play audio from the display through an external speaker, connect one end of an audio cable to the external speaker, and the other end to the display's **Audio Out** port.

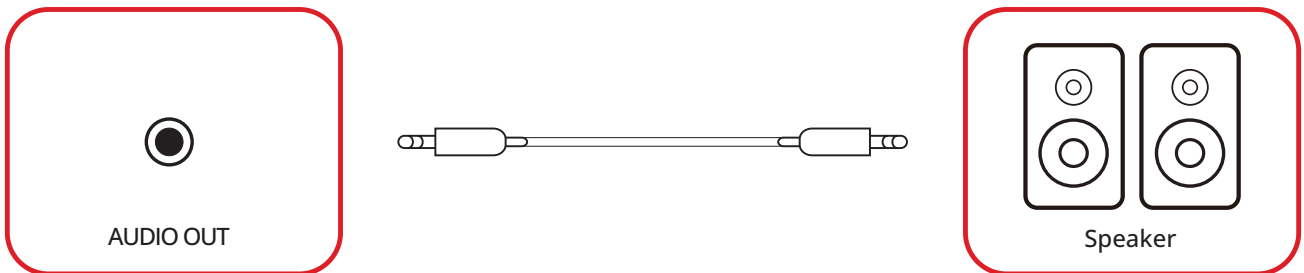

### SPDIF Connection

To connect to an external sound system, connect an optical cable from the display's **SPDIF** port to your sound system's optical connector.



## Video Output Connection (HDMI Out)



To output video via a display device:

1. Connect an HDMI cable to the **HDMI IN** port of your display device, and the other end to the **HDMI OUT** port of the display.
2. Press the **INPUT** button on the remote control and switch to the HDMI IN input source.

## Optional Connections

The display comes with an **OPS Slot** for an optional add-on such as a slot-in PC (e.g., VPC-25-O).

### Slot-in PC (OPS Slot) Installation

1. Carefully insert the slot-in PC into the **OPS Slot** of the display.

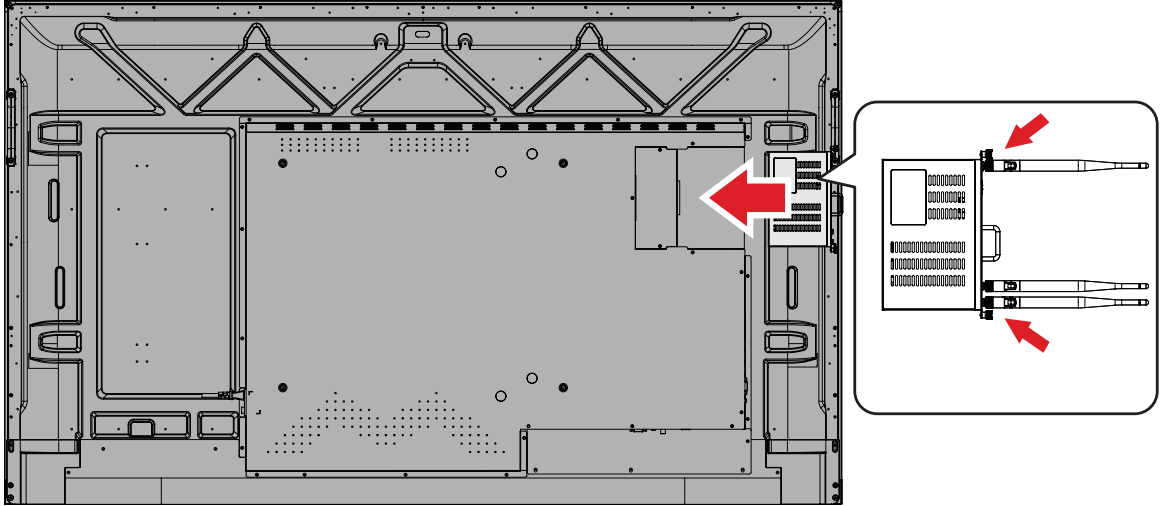

2. Secure the slot-in PC to the display.

# Using the Display

## Turning On/Off the Display

1. Make sure the power cord is connected, plugged into a power outlet, and the Power Switch is in the “on” position.

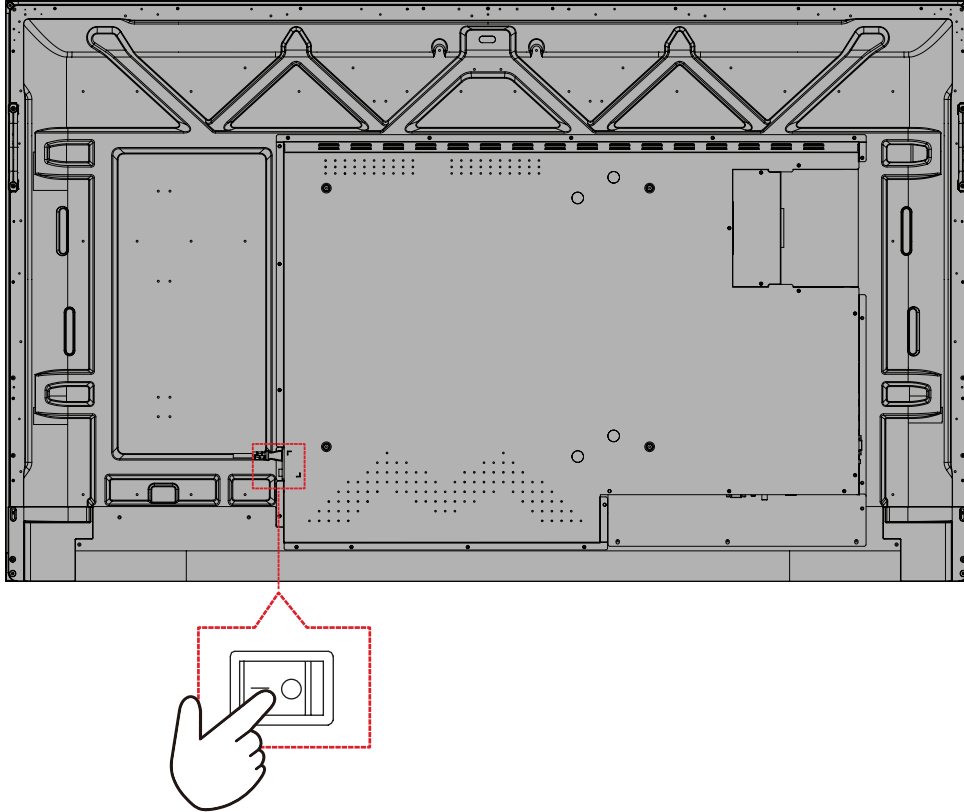

**NOTE:** The Power Switch is located at the rear of the display.

2. Press the  **Power** button to turn on the display.

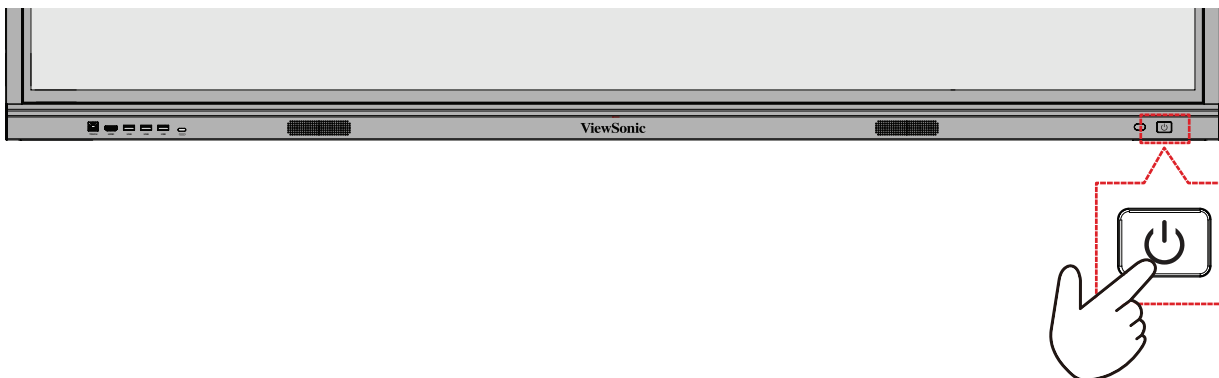

3. To turn the display off, press and hold the  **Power** button.

# Initial Launch Setup

When you first turn on your display, an initial setup wizard will launch.

## 1. Choose your preferred Language.

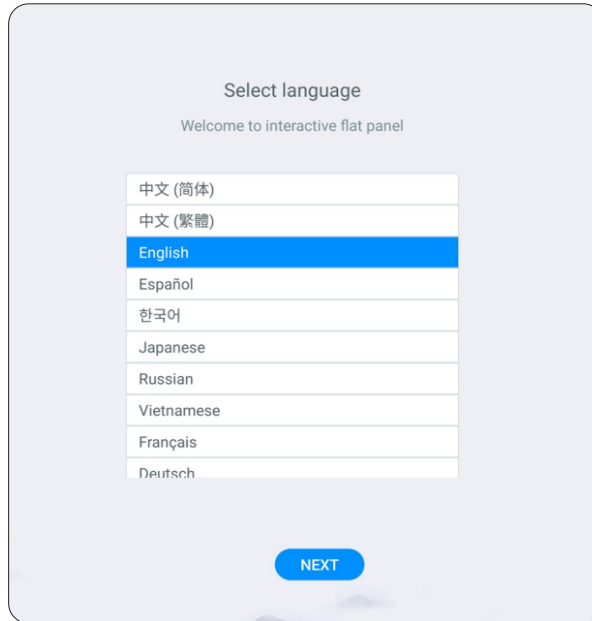

## 2. Setup and connect to a network.

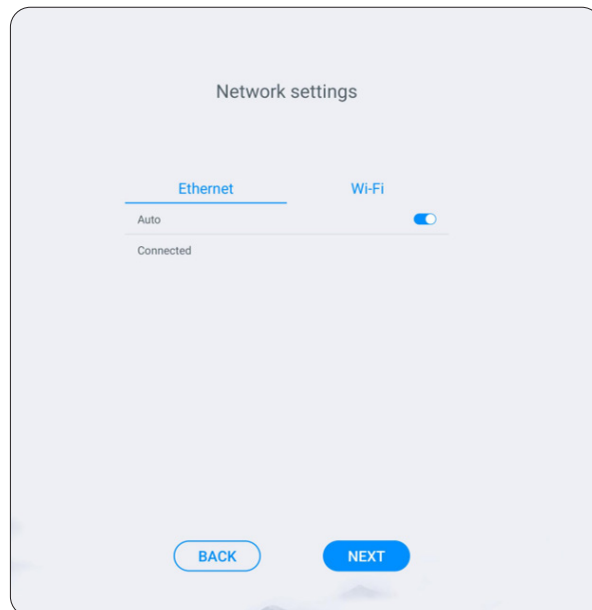

### 3. Set and adjust the Date and Time.

Time settings

NTP

Timezone Chennai, Kolkata, Mumbai, New Delhi GMT+5:30

Date & time 2024/04/24 13:01

BACK NEXT

### 4. Enter a name for the display.

Device name

Last step to finish

Enter name IN7501

BACK START



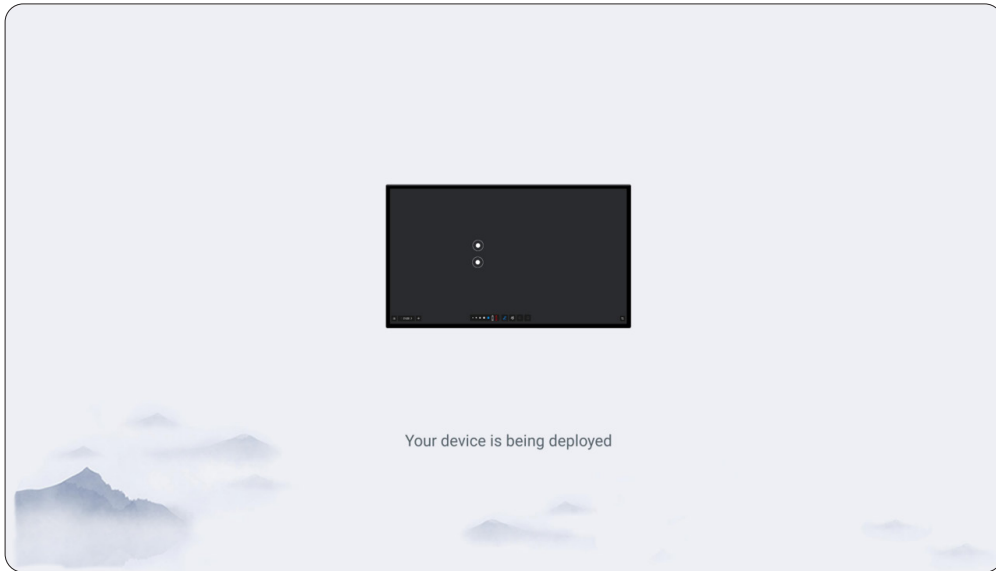

## 5. Complete the initial setup.

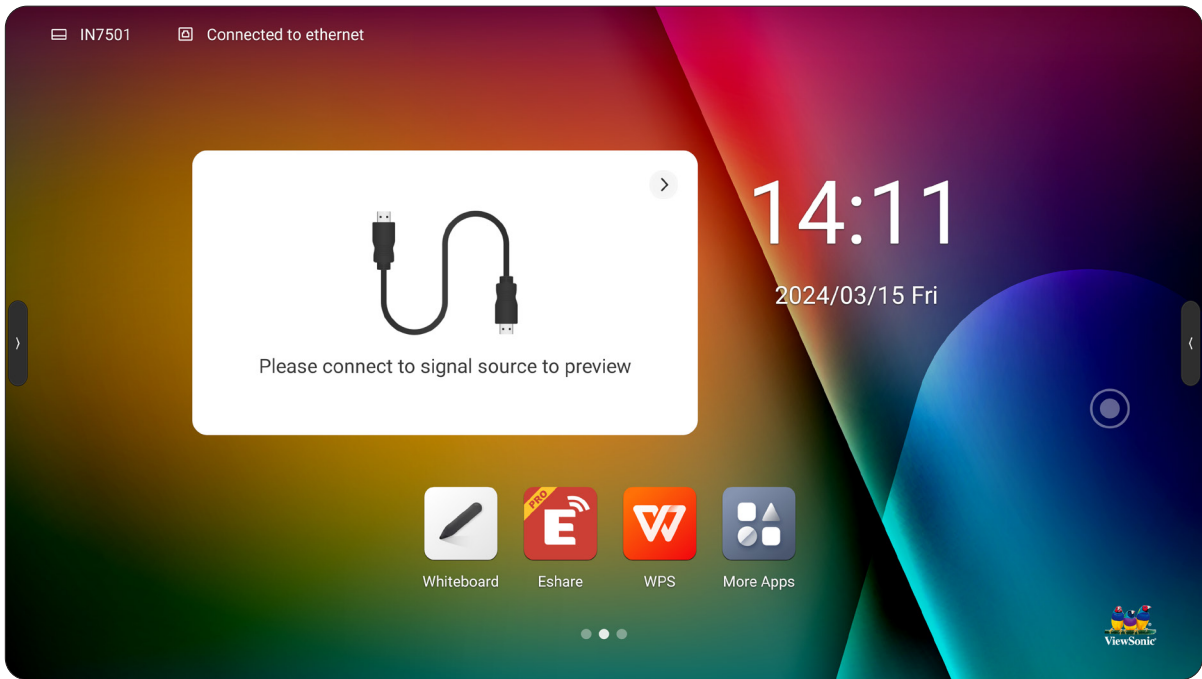

# Home Screen

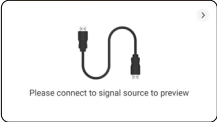
After the display is turned on and setup the Home Screen will load.



Item	Description
 <b>Source Window</b>	Input source preview window. Select the arrow in the top right corner to collapse the preview window.
 <b>Whiteboard</b>	Digital whiteboarding application.
 <b>EShare</b>	Wireless screen sharing application.
 <b>WPS</b>	Office application.
 <b>More Apps</b>	View all installed applications.

# Negative One Screen

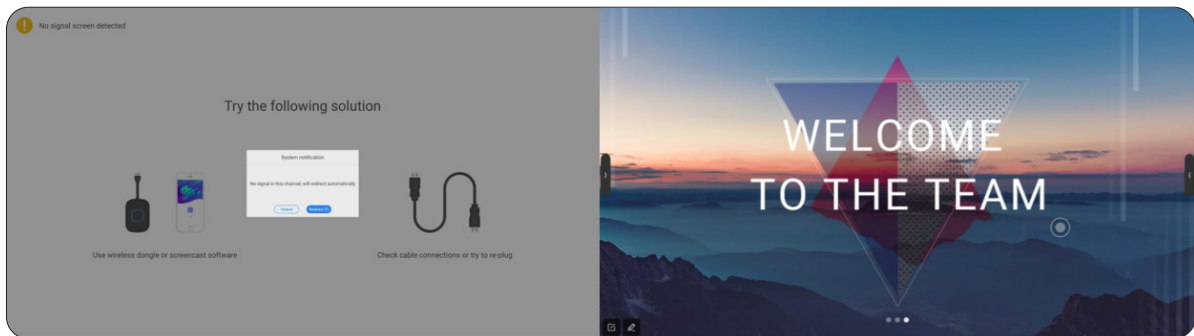
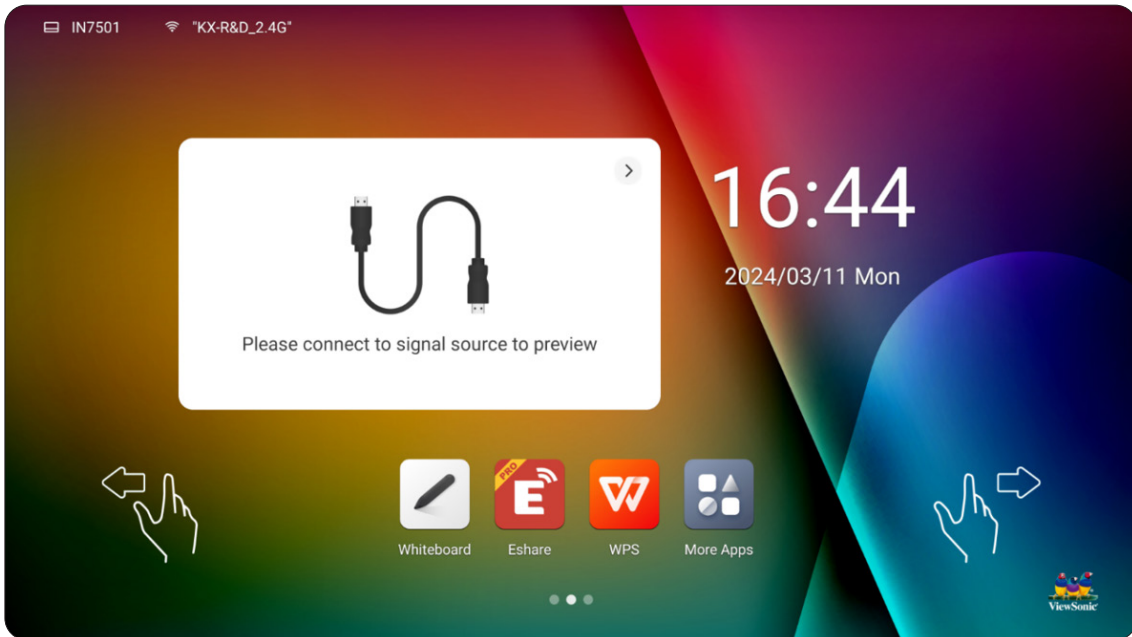

On the Home Screen you can slide left and right. The left negative one screen displays the input source and the right screen displays an application.

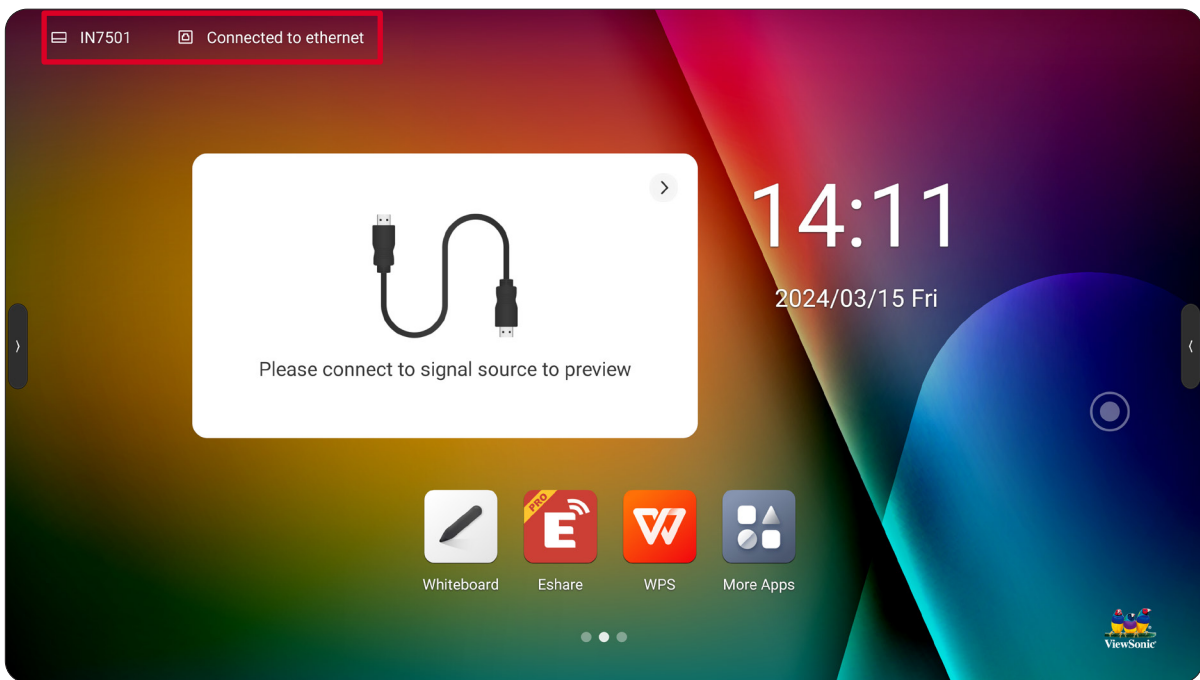

# Status Bar

The Status Bar shows the device name and network status.



Item	Description
 <b>Device Name</b>	Shows the name of the display.
 <b>Network Status</b>	Shows the network name and status.
 <b>Wi-Fi Status</b>	Shows the Wi-Fi network name and status.





## Toolbar

The Toolbar is where your applications and tools can be found. Trigger icons are on the edge of the launcher for quick access.



To launch an application or tool:

1. Select a Toolbar trigger icon.
2. Select the application or tool icon.







Item	Description
 <b>Return</b>	Return to the previous operation screen. <b>NOTE:</b> Only for the ViewBoard OS source.
 <b>Home</b>	Return to the Home Screen of the display.
 <b>Backstage</b>	Display all applications that are currently open.
 <b>Comments</b>	Annotate the overlay of any input source.
 <b>Control Panel</b>	Expand the display dashboard for more options and settings.

Item	Description
 <b>Input Source</b>	Select and change the input signal.

# Comments

Select the Comments icon (  ) in the Toolbar or on the Compass to start annotating on screen.



Item	Description
 <b>Close</b>	Close the Comment feature.
 <b>Save</b>	Save the content of the canvas.
 <b>Write</b>	Annotate on screen. Select the icon to adjust the line thickness and color.
 <b>Erase</b>	Remove any annotations.
 <b>QR Code Sharing</b>	Share the canvas' content by QR code.
 <b>Minimize</b>	Temporarily leave the Comments feature to access other applications or features of the display.





Item	Description
 Switch	Change the Comments' toolbar position.









# Control Panel







The Control Panel is divided into three sections: Shortcut Tools, Sidebar, and Applications.



## Shortcut Tools

Item	Description
 <b>Ethernet</b>	Enable or disable LAN connection.
 <b>Wireless</b>	Enable or disable Wireless network connection.
 <b>Hotspot</b>	Enable or disable the hotspot function.
 <b>Bluetooth</b>	Enable or disable Bluetooth connection.
 <b>Screen Shot</b>	Take a screenshot of the current screen and resize.



Item	Description
 <b>Vision Care</b>	Reduce the blue light emission of the screen.
 <b>Touch Sensing</b>	Enable or disable the Touch Sensor function. <b>NOTE:</b> When enabled, the brightness of the screen will reduce by 30% when touched. The brightness level will return to normal after five seconds without touch.
 <b>ECO</b>	Enable or disable to reduce power consumption. <b>NOTE:</b> When enabled, the brightness of the screen will be set to 25, and automatic brightness will be turned off. If you manually adjust the brightness or turn on automatic adjustment, the energy-saving mode will automatically turn off.
 <b>Touch Lock</b>	Enable or disable the Touch Lock function. <b>NOTE:</b> To unlock the Touch Lock: <ul style="list-style-type: none"> <li>• Use the remote control and press: V-, V-, V+, V+ in succession.</li> <li>• Use child lock files:               <ol style="list-style-type: none"> <li>1. Create a new text document</li> <li>2. Enter: U2FsdGVkX18v36IHH2OloQYdlbG+Y18YkDs9R1ACvSE=</li> <li>3. Save the file in the root directory of the USB device as: usb_child_key</li> <li>4. Make sure the file character is UTF-8.</li> <li>5. Insert USB key into USB Port to unlock.</li> </ol> </li> </ul>
 <b>Screen Lock</b>	Lock the display's screen for added security.
 <b>Listen Alone</b>	Turn off the backlight, but keep sound input. Double-tap the screen to exit.
 <b>Screen Off</b>	Enable or disable the screen backlight.
 <b>Turn Off OPS</b>	Turn off the external OPS power.

Item	Description
 <b>Power Off</b>	Power off the display.
 <b>Restart</b>	Restart the display.
 <b>Freeze Screen</b>	Freeze the current screen to write annotations.
 <b>Mute</b>	Turn off or turn on the sound.
 <b>Spotlight</b>	Concentrates the screen backlight in a designated area and the rest is dark. You can adjust the size of the spot area, or adjust the darkness of the rest of the area.
 <b>Curtain</b>	Enable or disable the curtain function. You can adjust the size of the screen up, down, left, right, and change the background image.

## Sidebar

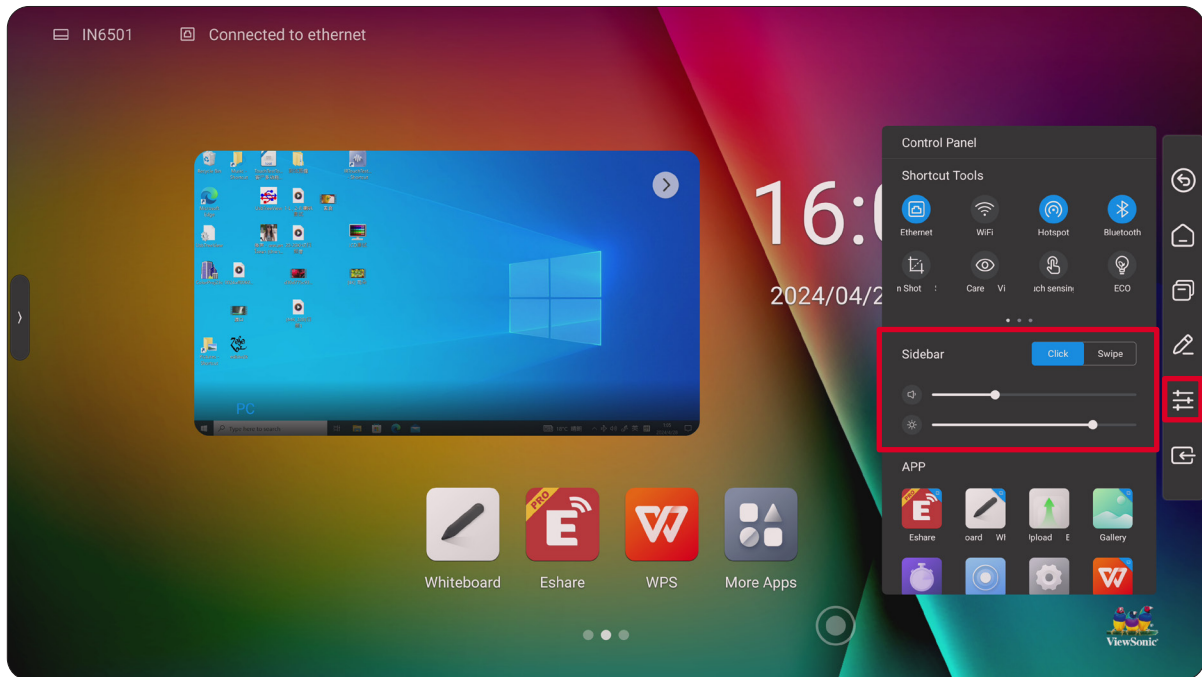
Set the behavior of the trigger icons and quickly adjust the volume and brightness levels.



Item	Description
 <b>Volume</b>	Adjust the sound level.
 <b>Brightness</b>	Adjust the screen brightness level.

## Applications

View and open installed applications. Long pressing the application icon will give the option for Multi-Window. Applications can be accessed from the Toolbar, directly from the Home Screen, or by selecting the More Apps icon (  ).

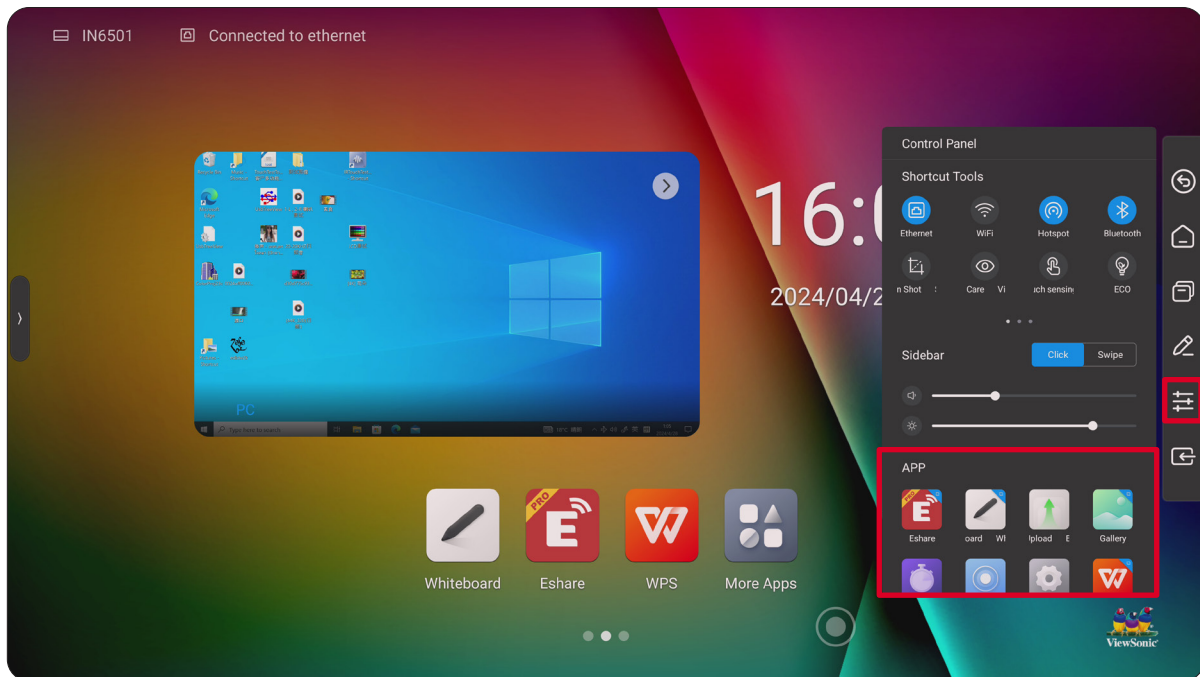

## Multi-Window

Multi-Window allows the user to open up to four smaller application windows at the same time.

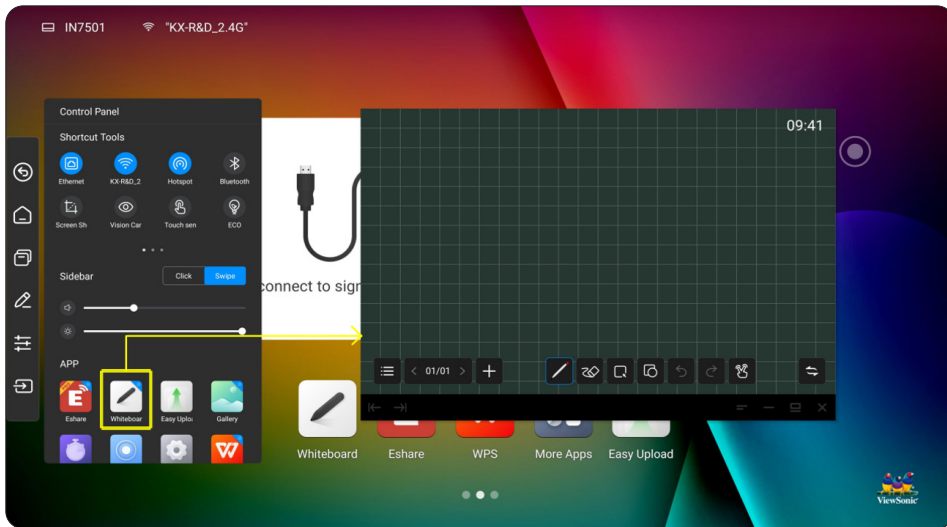

There are two methods to use Multi-Window:

### 1. From More Apps

After selecting the More Apps icon (🗄️), long press the application and select **Free window** from the pop-up window.

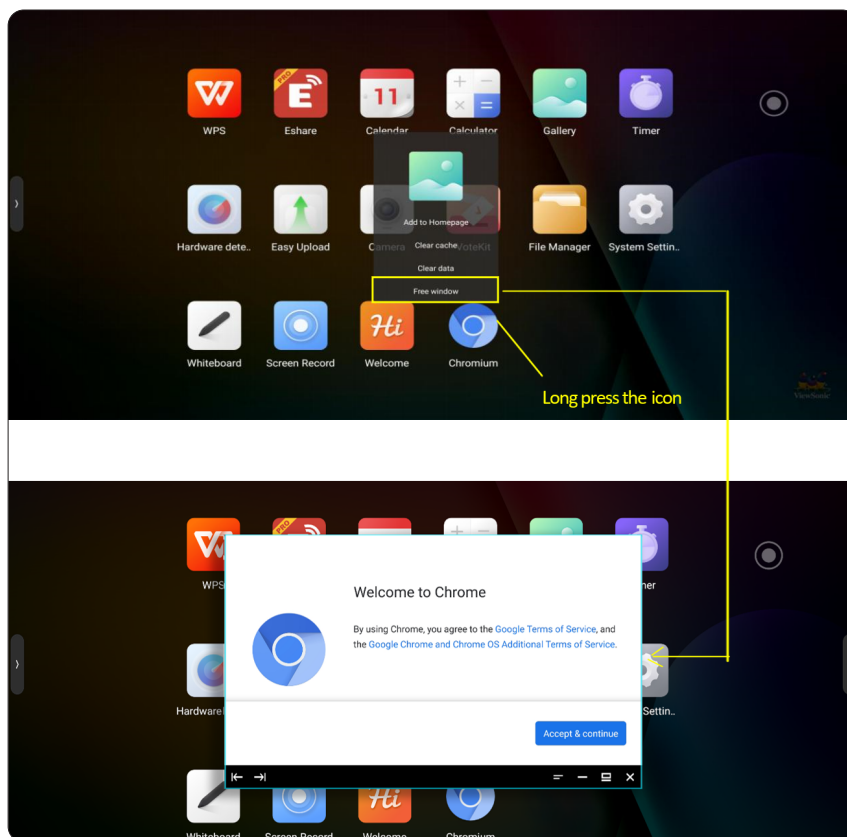

### 2. From the Toolbar Control Panel

Long press the application and select the corner marker that appears.

# Input Source

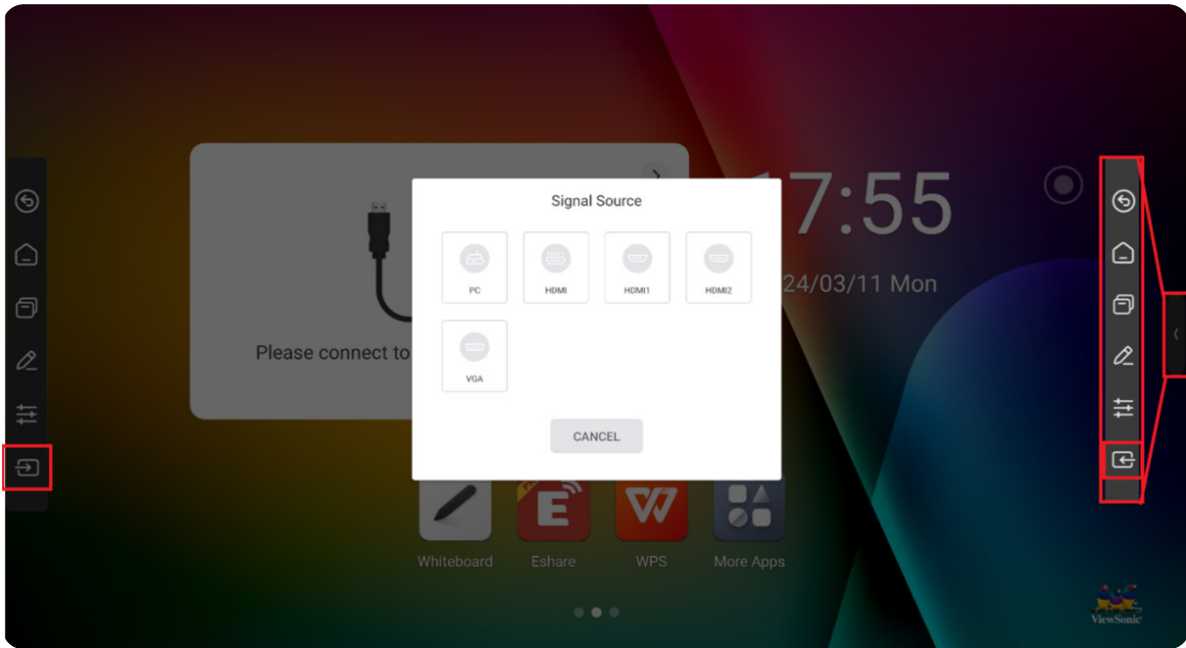

Item	Description
 <b>Input Source</b>	Select and change the input signal.

## Compass

The Compass acts as a quick access method to select features and applications. To activate the Compass, long press the display's screen with five fingers.

**NOTE:** Please make sure Compass is enabled in: **System Settings > General > Compass.**

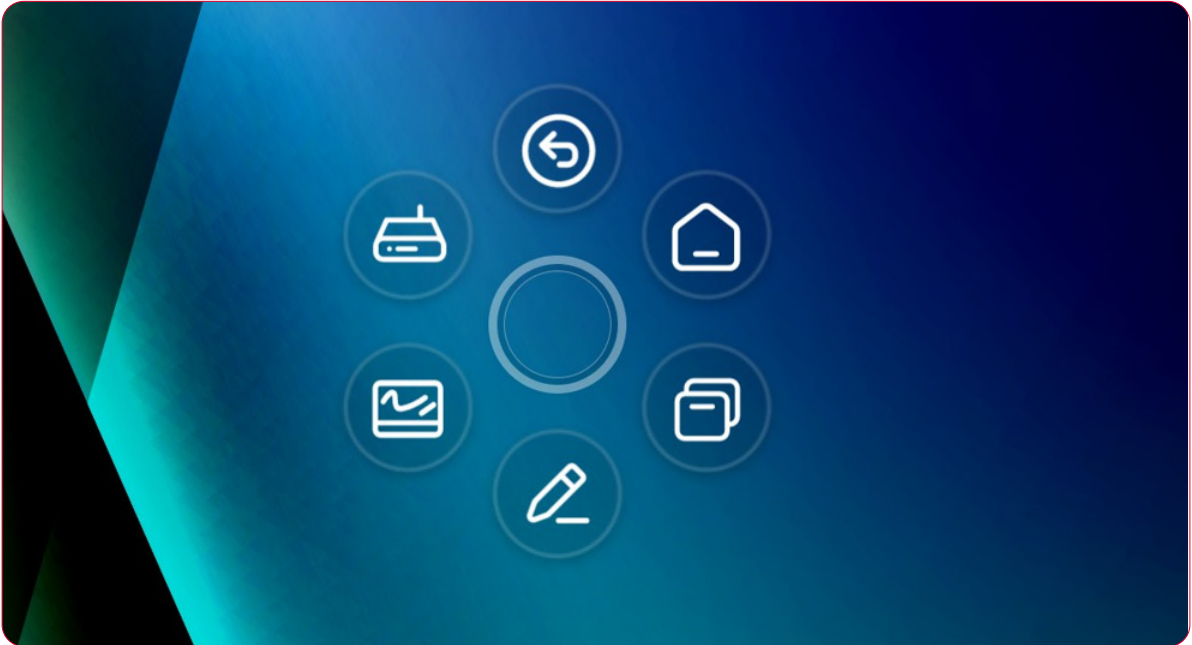

## **Low Blue Light Filter and Eye Health**

The low blue light filter blocks high-energy blue light for a more comfortable viewing experience.

### **Calculating Breaks**

When viewing screens for extended periods, it is recommended to take periodic breaks from viewing. Short breaks of at least 10 minutes are recommended after one (1) hour of continuous viewing.

Taking shorter, more frequent breaks are generally more beneficial than longer, less frequent breaks.

### **Focus Fatigue (20-20-20 Rule)**

To reduce the risk of eye fatigue by constantly looking at the screen, look away from the screen at least every 20 minutes and gaze at a distant object (at least 20 feet away) for at least 20 seconds.

### **Looking at Distant Objects**

While taking breaks, users can further reduce eye strain and dryness by focusing on objects that are further away from them for 10-15 seconds, then gaze at something up close for 10-15 seconds. Repeat this up to 10 times. This exercise reduces the risk of your eyes' focusing ability to "lock up" after prolonged computer work.

## Eye and Neck Exercises

### Eye Exercises

Eye exercises can help minimize eye strain. Slowly roll your eyes to the left, right, up, and down. Repeat as many times as needed.

#### Exercises for the eyes

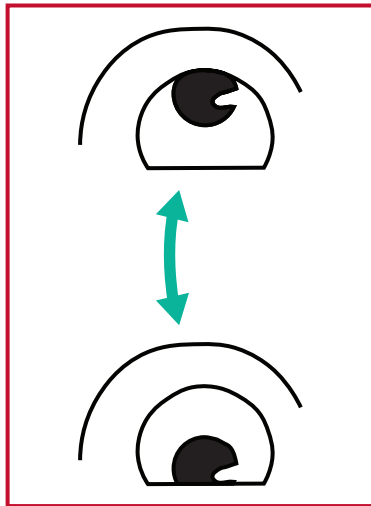

(1) Keep the body and the head upright. Move the eyes up to look at the ceiling, then turn down to look at the floor.

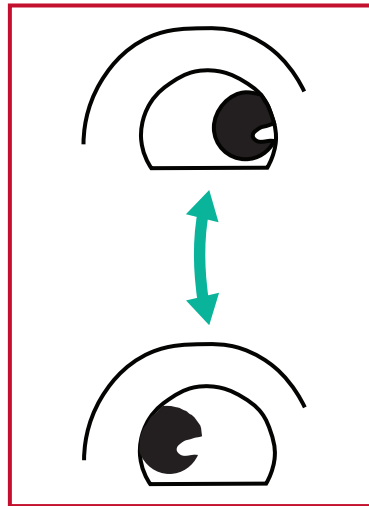

(2) Move the eyes left and right slowly to look at objects on the two sides.

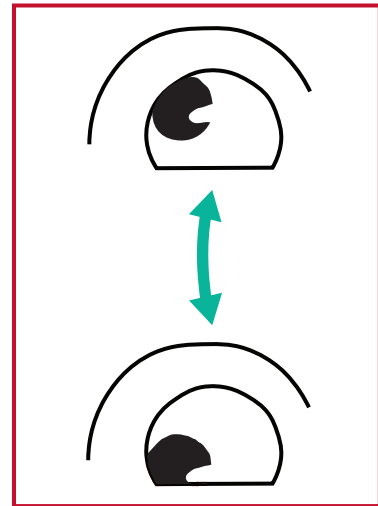

(3) Move the eyes to look at objects at the right upper direction and then right lower direction. Repeat for the left upper and left lower directions.

### Neck Exercises

Neck exercises can also help minimize eye strain. Relax your arms and let them hang at your sides, bend forward slightly to stretch the neck, turn your head to the right and to the left. Repeat as many times as needed.

# System Settings

## Network



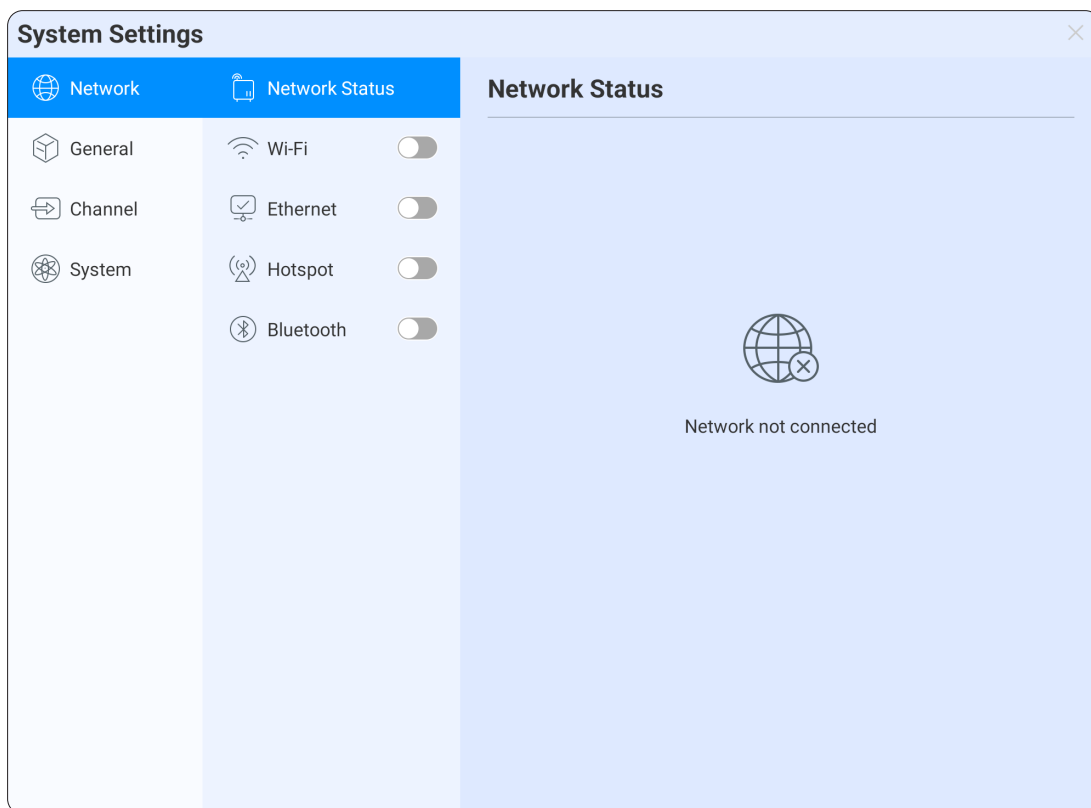

Set up and manage Wi-Fi, Ethernet, Hotspot, and Bluetooth settings.

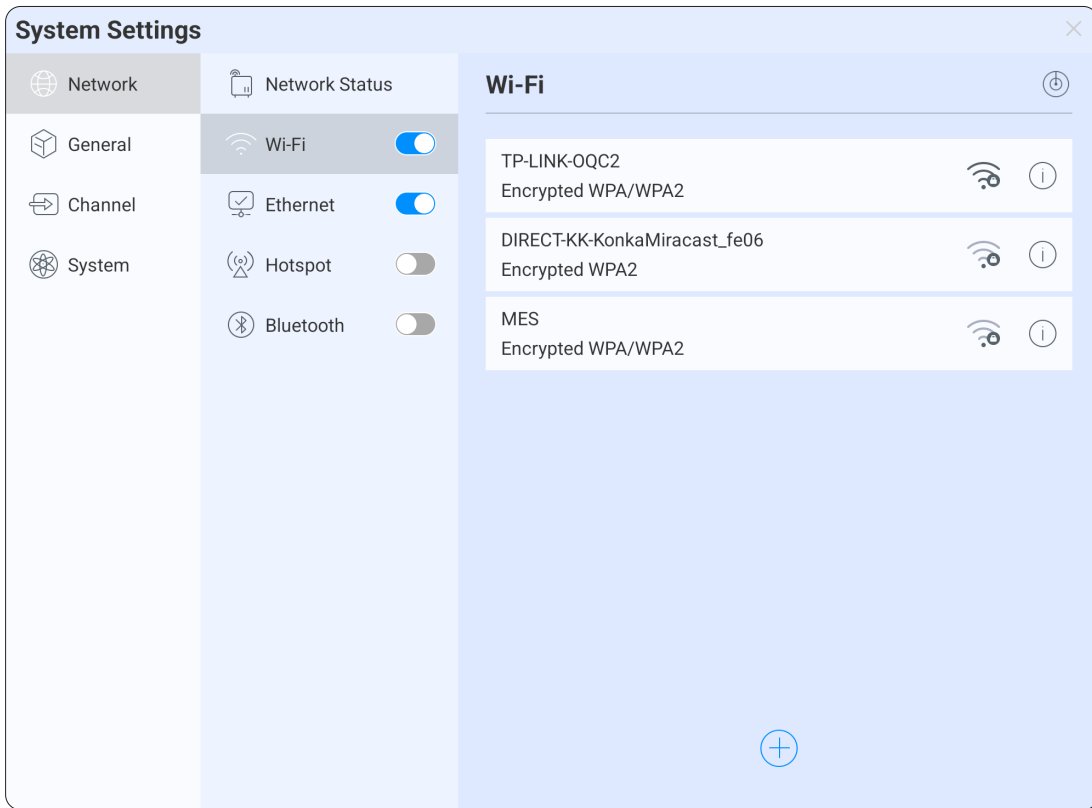

# Wi-Fi

Setup and manage wireless access points.



Item	Description
	Turn Wi-Fi on or off.
	Refresh the available networks list.
	Add a hidden network by entering the network's name and password.
	Connect to the listed network.

# Ethernet

Set the local network and proxy.

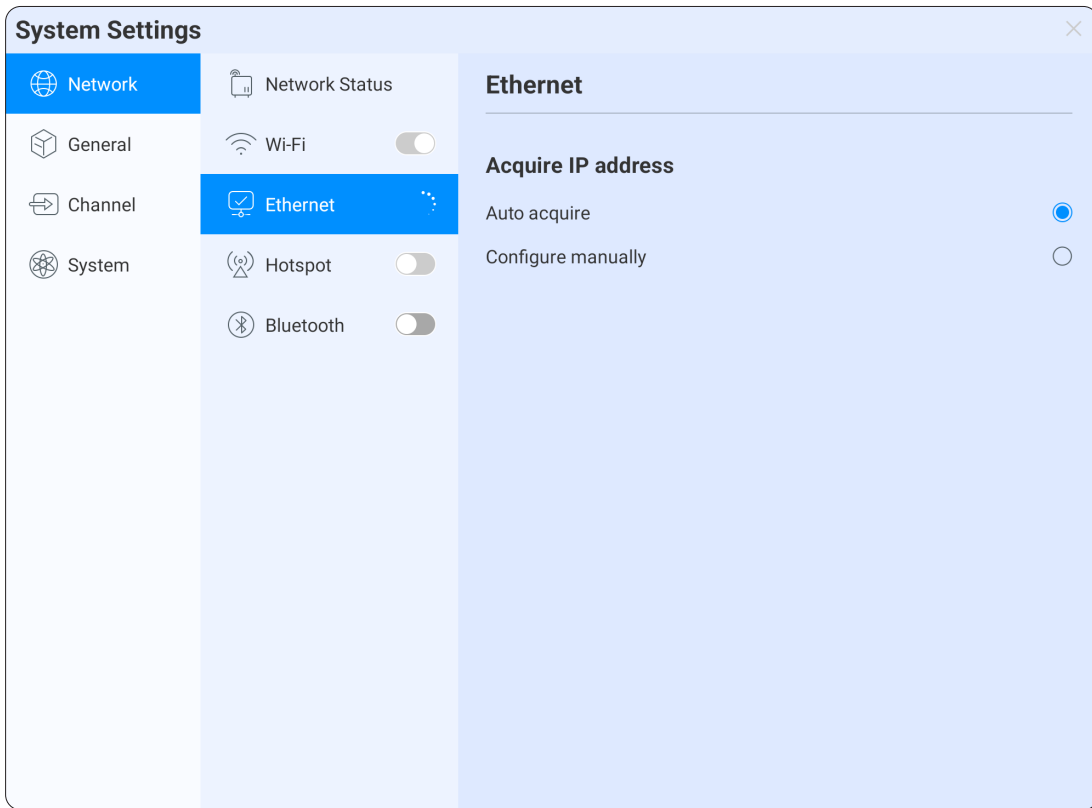

Item	Description
	Turn Ethernet on or off.
<b>Auto Acquire</b>	Manually enter the IP address, default gateway, subnet mask, DNS1, and DNS2 settings.
<b>Configure Manually</b>	Select any network in the list and enter the login password to connect.

# Hotspot

Set and share the display's internet connection with other devices.

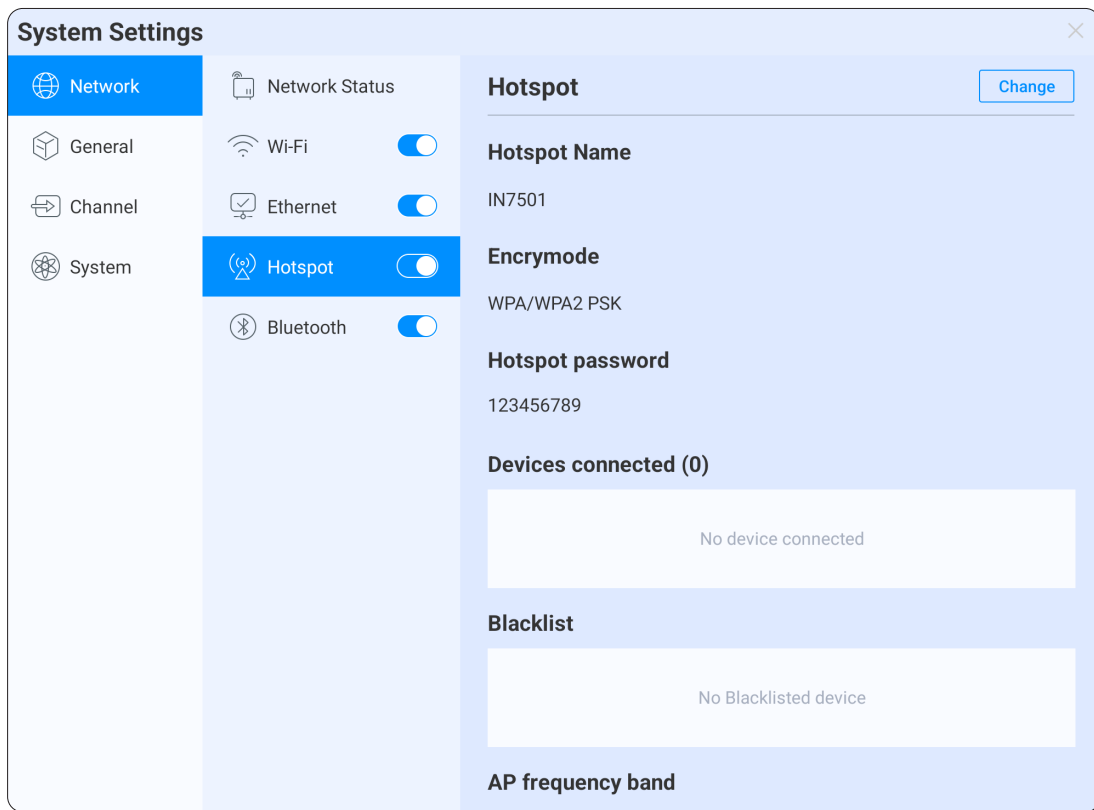

Item	Description
	Turn Hotspot on or off.
<b>Hotspot Password</b>	Shows the current hotspot password. Select <b>Change</b> to modify the hotspot password.
<b>Devices Connected</b>	Shows the devices that are connected to the hotspot.
<b>Blacklist</b>	Shows the blocked devices that cannot connect to the hotspot.

# Bluetooth

Manage connections, set the device name and discoverability, and share files.

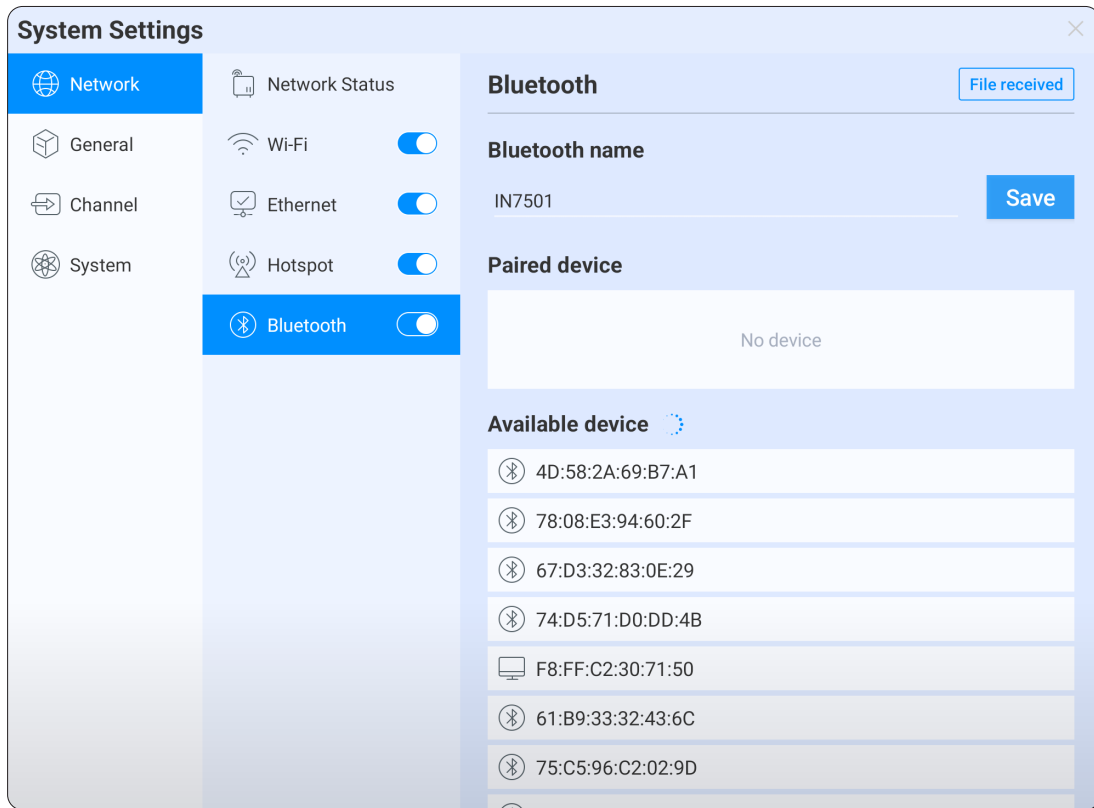

Item	Description
	Turn Bluetooth on or off.
<b>File Received</b>	Show all received files.
<b>Bluetooth Name</b>	Set the name of the display's Bluetooth name.
<b>Paired Device</b>	Shows all connected devices.
<b>Available Device</b>	Shows all available devices that can be connected to.

# General

Set up and manage Custom, Sound, Display, Compass, Gesture, and Screen Recording settings.

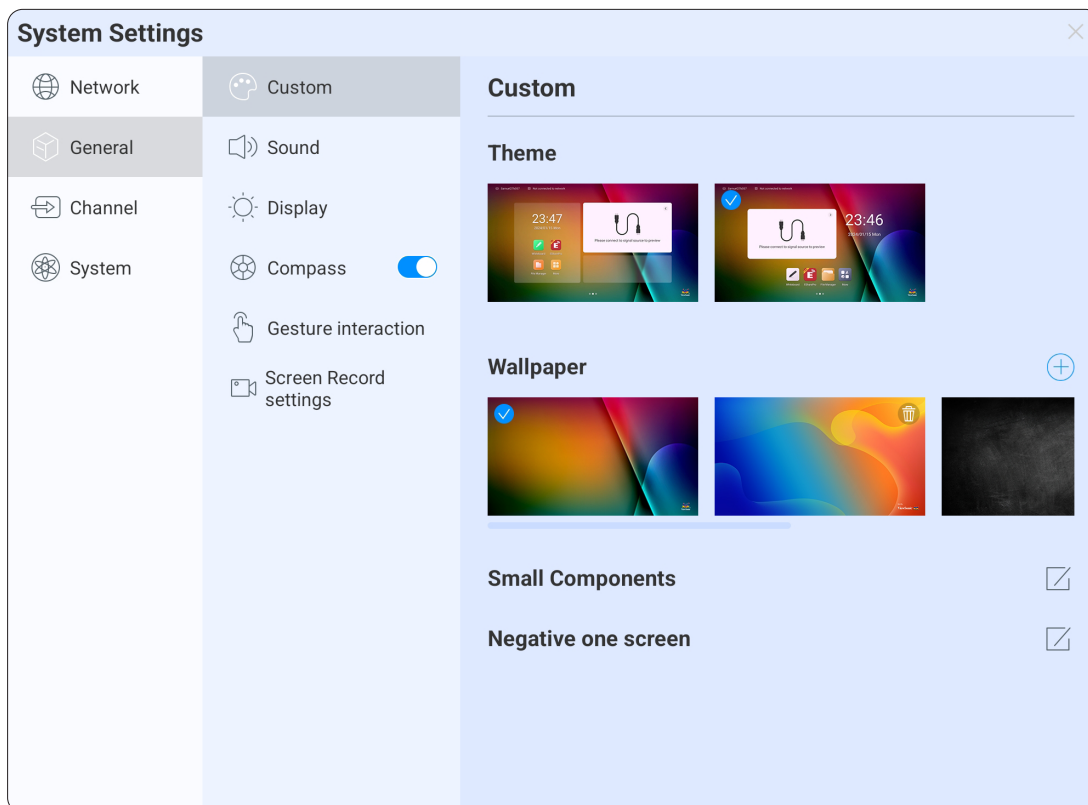

# Custom

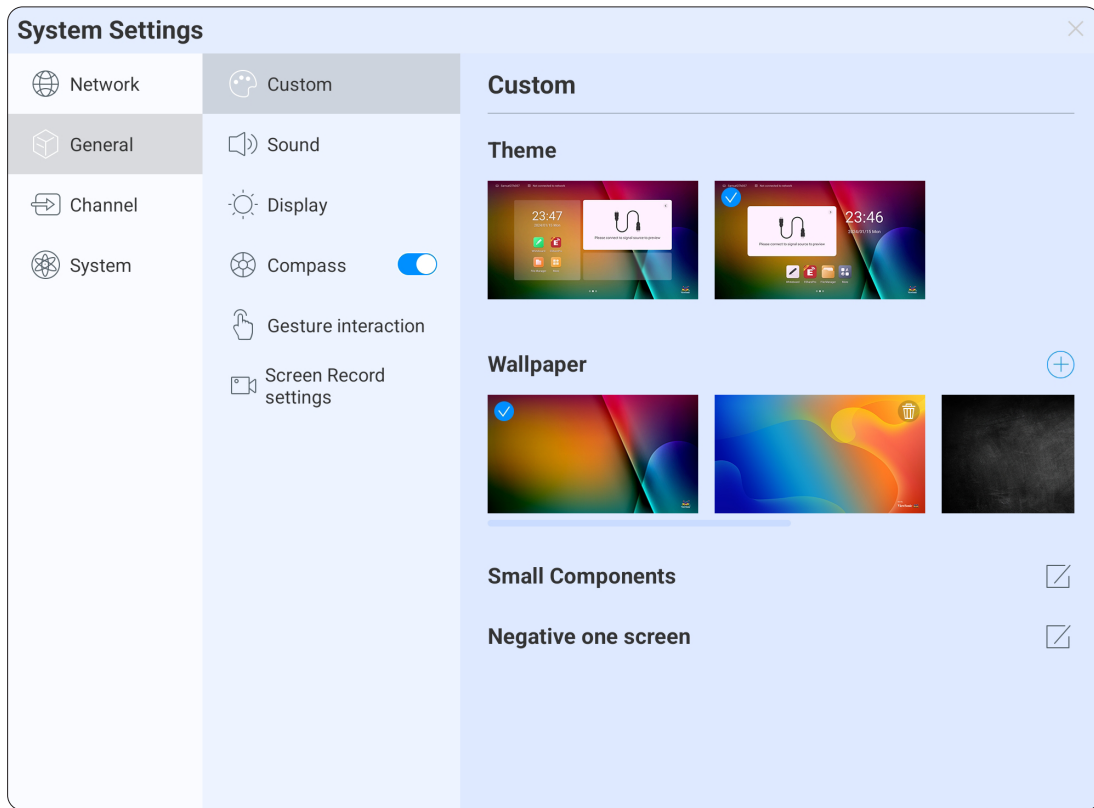

Item	Description
<b>Theme</b>	Choose from two themes that will modify the layout of the Home Screen.
<b>Wallpaper</b>	The system provides 10 wallpapers by default. Select any of the images to change the wallpaper. Select the add icon ⊕ to add a custom wallpaper.

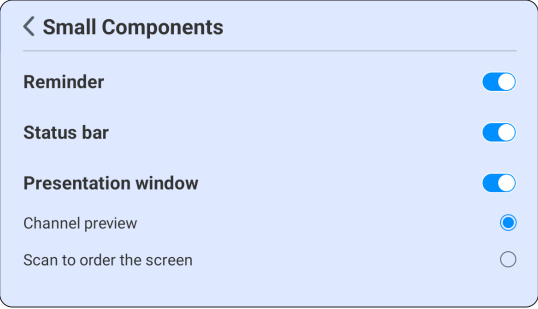
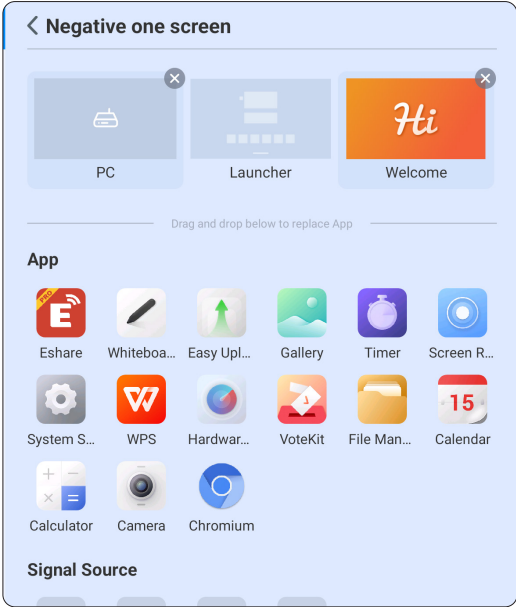
Item	Description								
<p align="center"><b>Small Components</b></p>									
	<table border="1"> <thead> <tr> <th data-bbox="456 510 700 568">Item</th> <th data-bbox="700 510 1374 568">Description</th> </tr> </thead> <tbody> <tr> <td data-bbox="456 568 700 618"><b>Reminder</b></td> <td data-bbox="700 568 1374 618">Set reminders on the Home Page.</td> </tr> <tr> <td data-bbox="456 618 700 745"><b>Status bar</b></td> <td data-bbox="700 618 1374 745">When enabled, the user name and Wi-Fi information will be displayed in the top left corner of the screen.</td> </tr> <tr> <td data-bbox="456 745 700 1111" rowspan="2"><b>Presentation window</b></td> <td data-bbox="700 745 1374 891"> <p><u>Channel preview</u></p> <p>The preview window on the Home Screen will display information about the signal source.</p> </td> </tr> <tr> <td data-bbox="700 891 1374 1111"> <p><u>Scan to order the screen</u></p> <p>The preview window on the Home Screen will display a QR code. Scanning the QR code will connect your device to the display and cast the device's content in the preview window.</p> </td> </tr> </tbody> </table>	Item	Description	<b>Reminder</b>	Set reminders on the Home Page.	<b>Status bar</b>	When enabled, the user name and Wi-Fi information will be displayed in the top left corner of the screen.	<b>Presentation window</b>	<p><u>Channel preview</u></p> <p>The preview window on the Home Screen will display information about the signal source.</p>
Item	Description								
<b>Reminder</b>	Set reminders on the Home Page.								
<b>Status bar</b>	When enabled, the user name and Wi-Fi information will be displayed in the top left corner of the screen.								
<b>Presentation window</b>	<p><u>Channel preview</u></p> <p>The preview window on the Home Screen will display information about the signal source.</p>								
	<p><u>Scan to order the screen</u></p> <p>The preview window on the Home Screen will display a QR code. Scanning the QR code will connect your device to the display and cast the device's content in the preview window.</p>								
<p align="center"><b>Negative One Screen</b></p>	 <p>Set the Home Screen to slide left and right. After enabling this function, users can drag and drop the application they want to the corresponding page.</p>								

# Sound

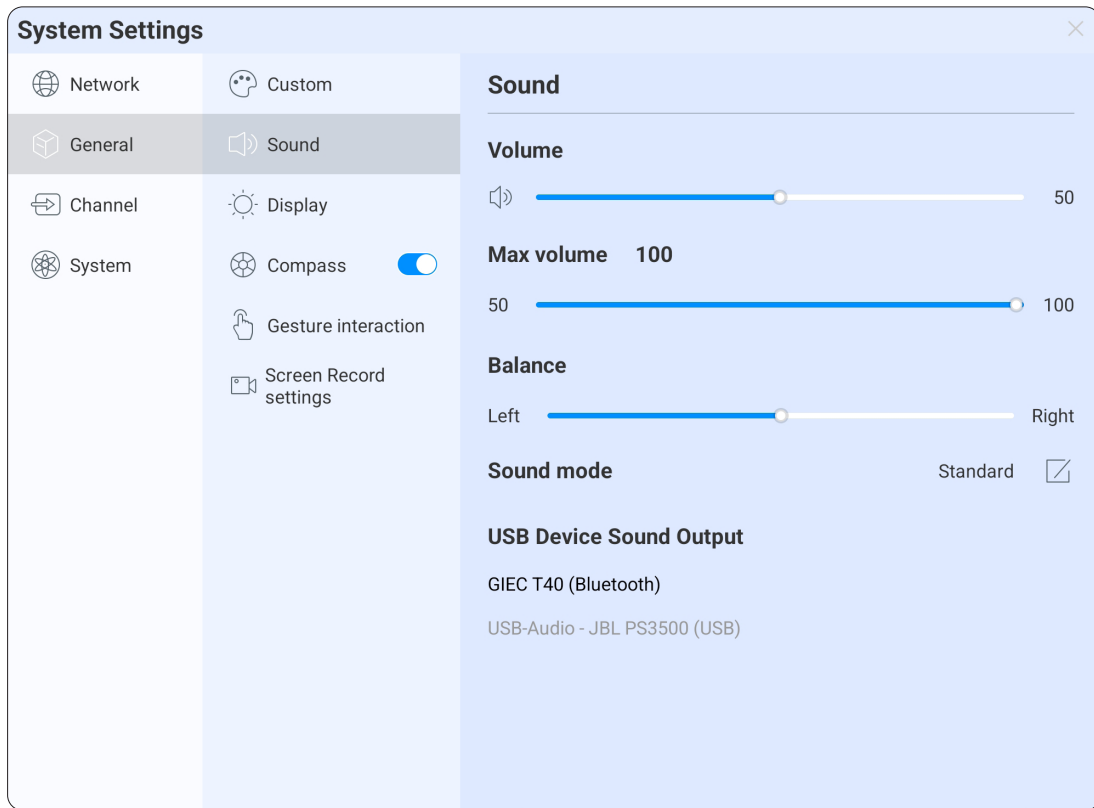

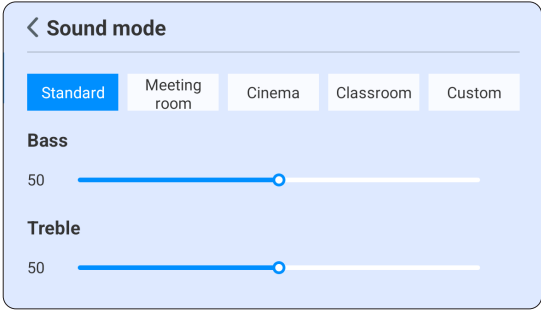
Item	Description
<b>Volume</b>	Adjust the sound level.
<b>Max volume</b>	Set the maximum volume level.
<b>Balance</b>	Adjust the left and right channel balance.
<b>Sound mode</b>	 <p>Select from one of the preset modes or create your own.</p>
<b>Sound output</b>	When connected to a USB or Bluetooth audio device, the device name will be displayed.

# Display

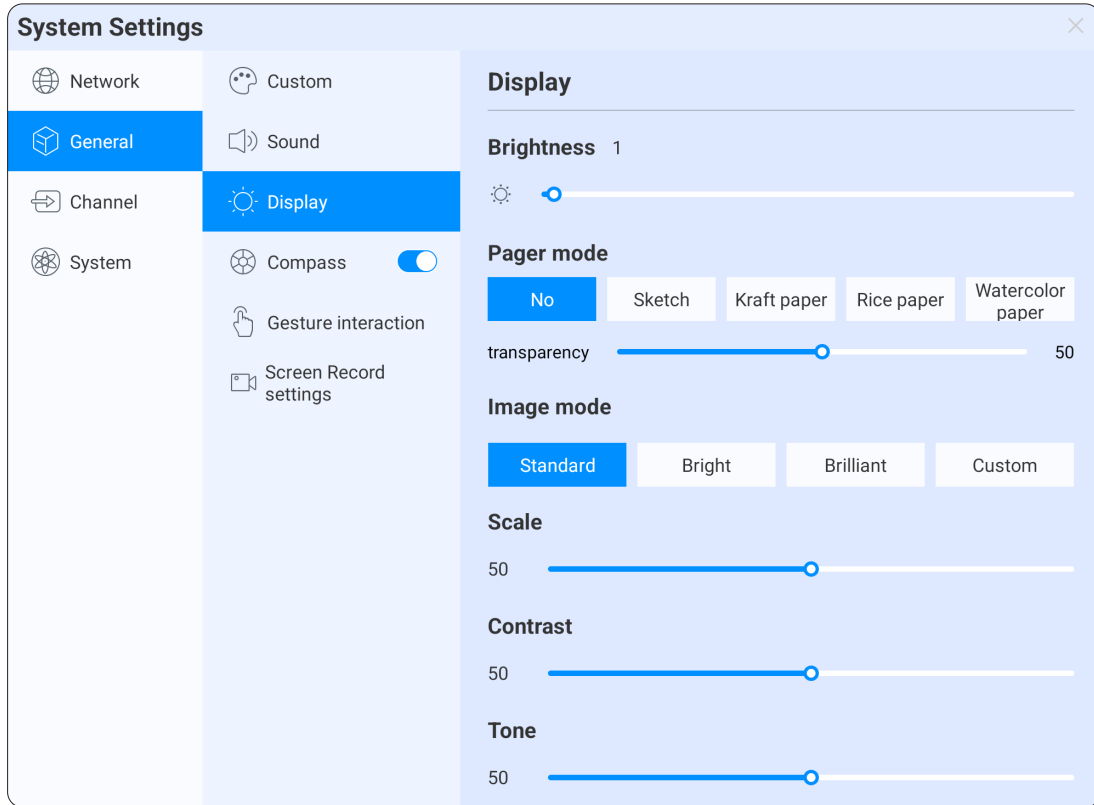

Item	Description
<b>Brightness</b>	Adjust the background black levels of the screen image.
<b>Pager mode</b>	Simulate the display effect of different types of paper.
<b>Image mode</b>	Select from one of the preset modes or create your own.
<b>Color temperature</b>	Adjust the color appearance using the Kelvin scale.

# Compass

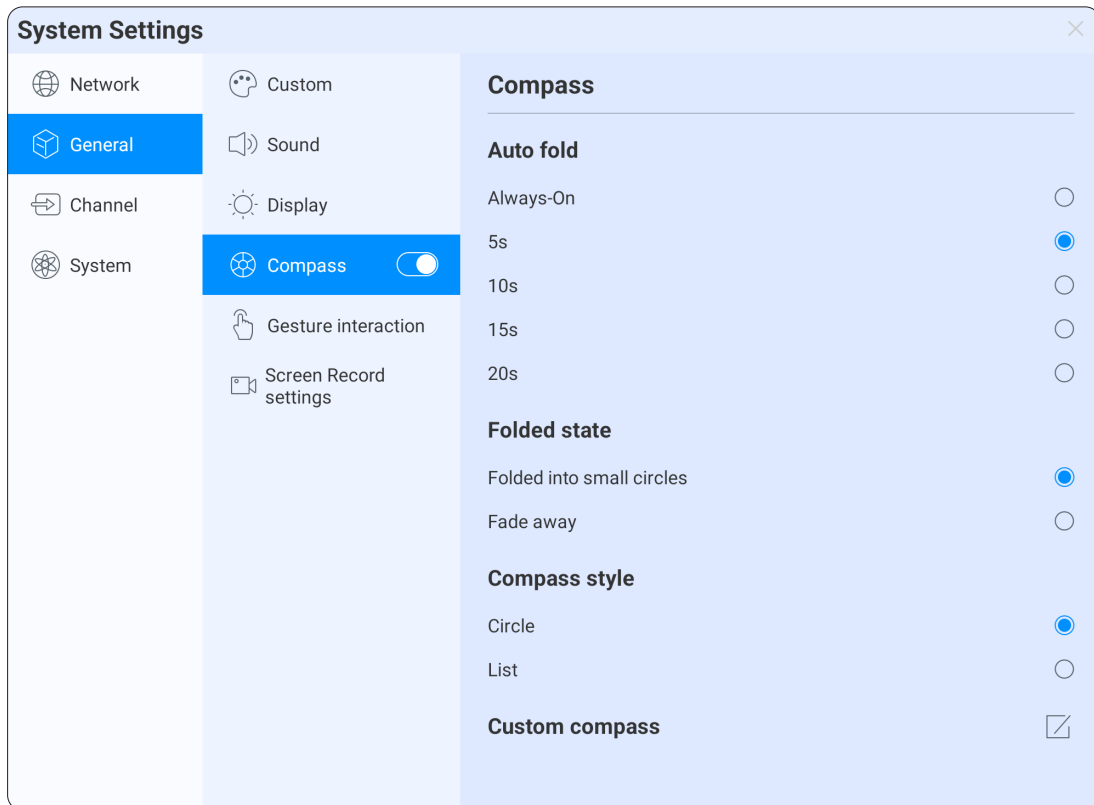

Item	Description
	Turn the Compass feature on or off.
<b>Auto fold</b>	Set the display time of the Compass.
<b>Folded state</b>	<p><u>Folded into small circles</u> The floating ball will turn into small circles.</p> <p><u>Fade away</u> The floating ball will gradually disappear.</p>
<b>Compass style</b>	Set the style of the compass: circle or list.

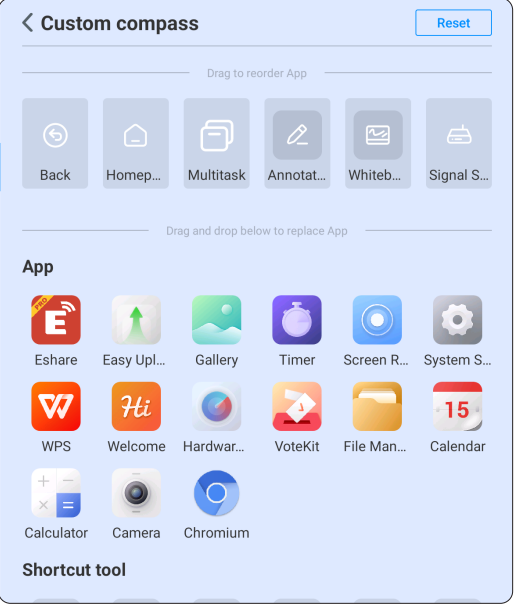
Item	Description
<p><b>Custom compass</b></p>	 <p>The screenshot shows the 'Custom compass' interface. At the top, there is a title bar with a back arrow, the text 'Custom compass', and a 'Reset' button. Below the title bar, there are two sections for reordering and replacing apps. The first section, 'Drag to reorder App', contains six icons: Back, Home, Multitask, Annotat..., Whiteb..., and Signal S... The second section, 'Drag and drop below to replace App', contains a grid of app icons under the heading 'App'. The apps shown are Eshare, Easy Up..., Gallery, Timer, Screen R..., System S..., WPS, Welcome, Hardwar..., VoteKit, File Man..., and Calendar. Below the app grid, there are three more icons: Calculator, Camera, and Chromium. At the bottom, there is a 'Shortcut tool' section.</p> <p>Customize the Compass applications.</p>

# Gesture Interaction

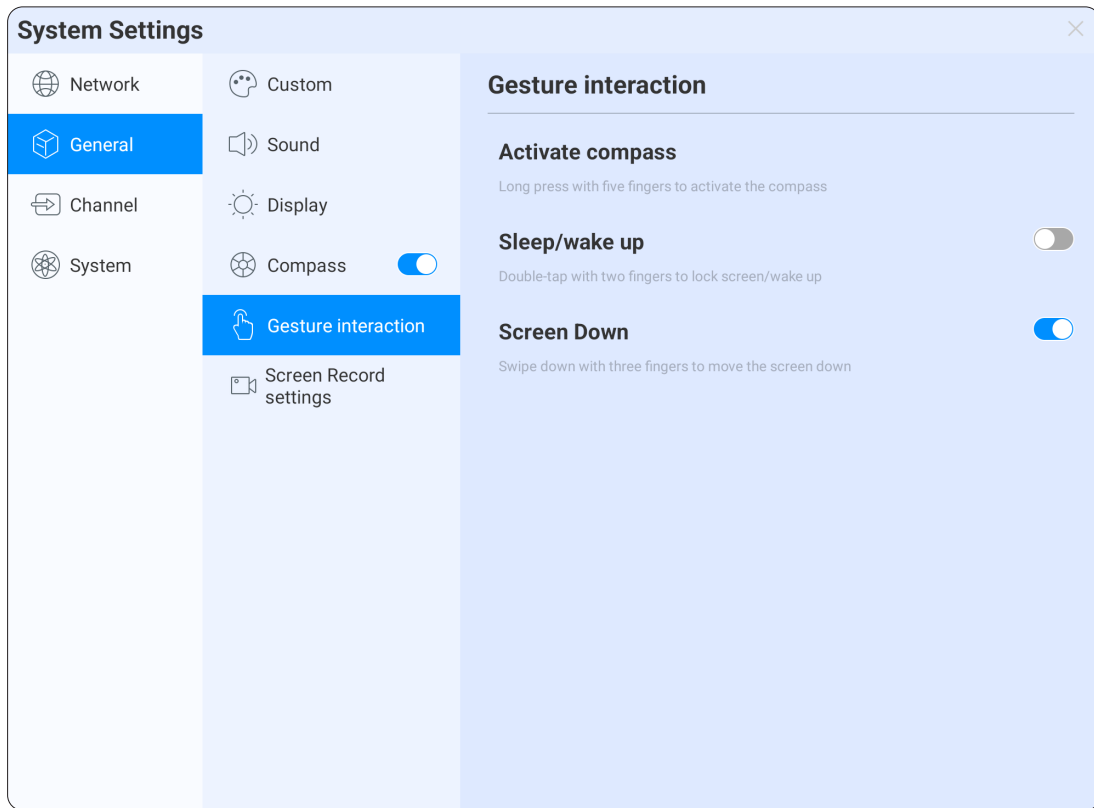

Item	Description
<b>Activate compass</b>	Long press the display's screen with five fingers to activate the Compass.
<b>Sleep/wake up</b>	When enabled, double tapping the display's screen with two fingers will lock the screen/wake it.
<b>Screen Down</b>	When enabled, using three fingers to swipe down from the top of the screen will move the entire screen down. <b>NOTE:</b> This is only available under OPS/HDMI/VGA input source.

# Screen Record Settings

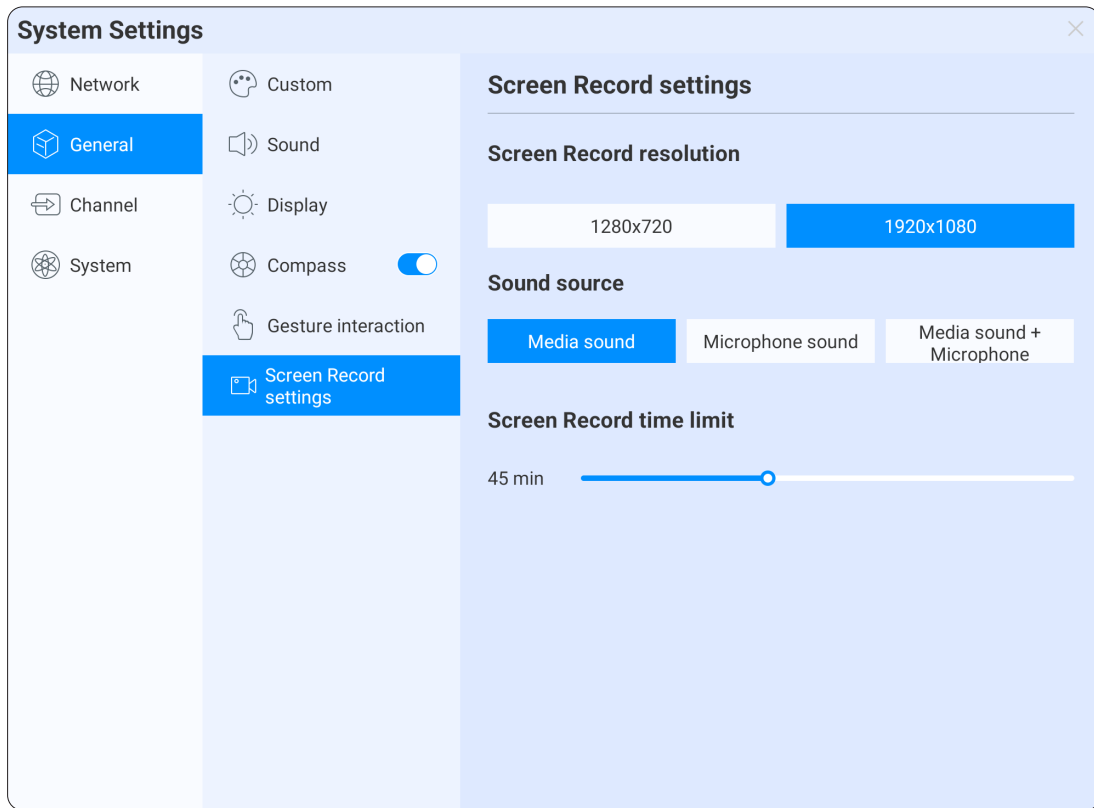

Item	Description
<b>Screen Record resolution</b>	Set the recording resolution.
<b>Sound source</b>	Set the sound source for recordings.
<b>Screen Record time limit</b>	Set the maximum recording time.

# Channel

Set up and manage input source settings. After successfully connecting to HDMI OUT, **HDMI OUT Settings** will appear and users can choose the corresponding resolution output.

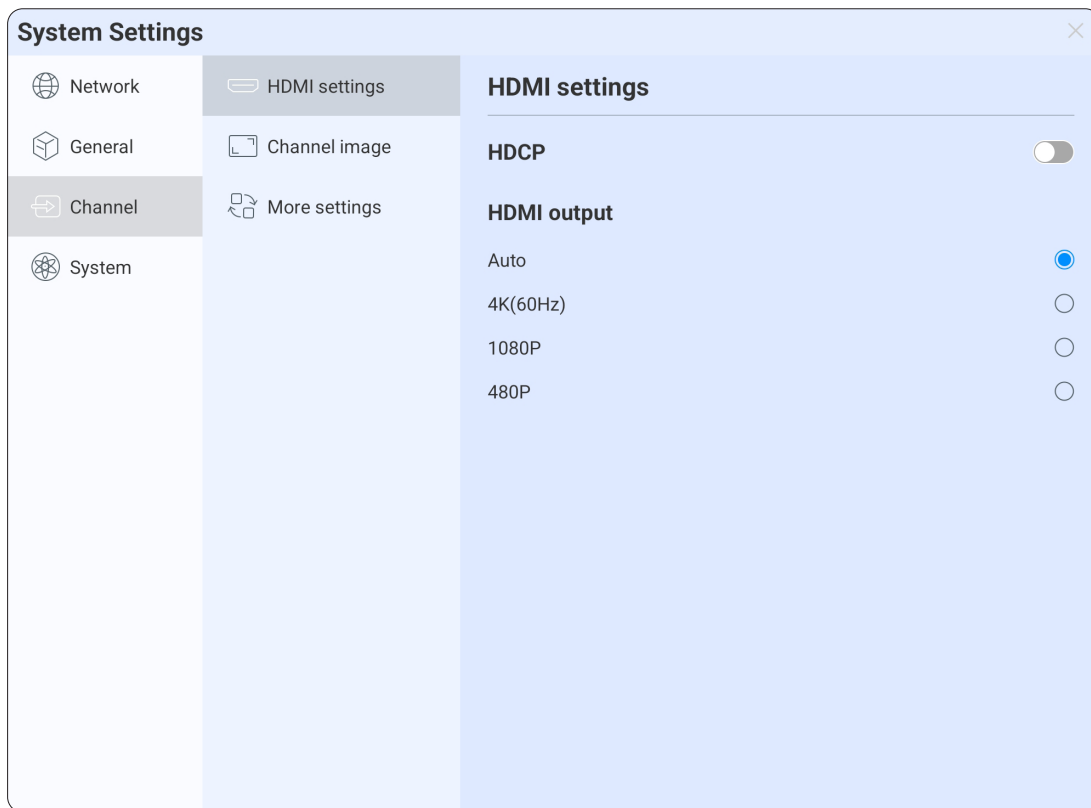

# Channel Image

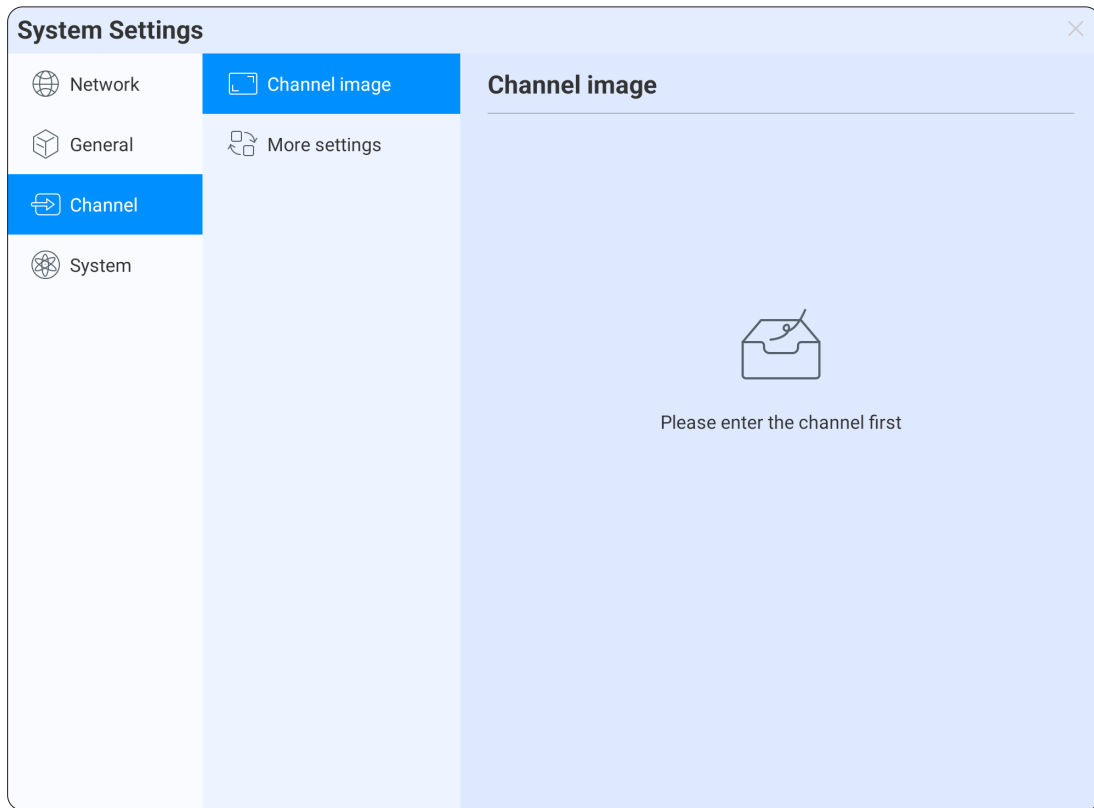

Item	Description
Scale Mode	Set the display scale of the current input source on the display.
PC Mode	Set the screen display mode.

# More Settings

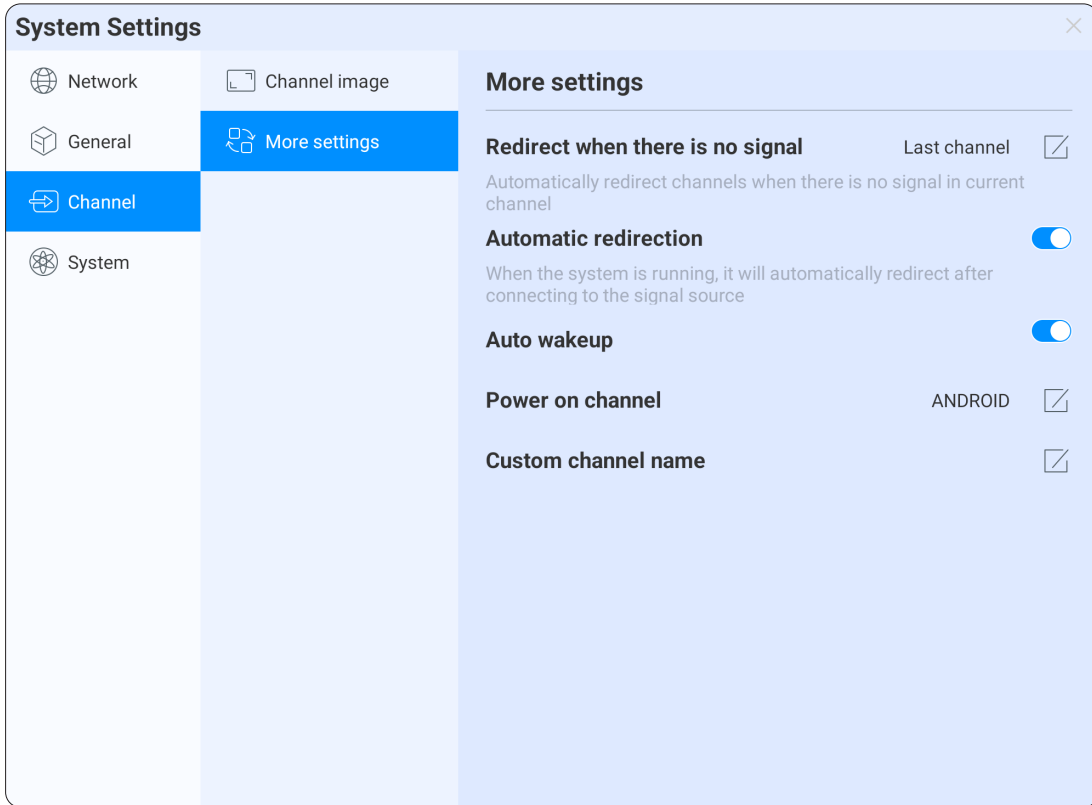

Item	Description
<b>Redirect when there is no signal</b>	Automatically redirect channels when there is no signal in the current channel.
<b>Automatic redirection</b>	When the system is running, it will automatically redirect after connecting to the signal source.
<b>Auto wake up</b>	When the display is in standby or sleep mode, automatically wake up the device.
<b>Power on channel</b>	Set the input source for when the display is turned on.
<b>Custom channel name</b>	Set labels for each input source.

# System

Set up and manage Date & Time, Language & Input method, Power Status, System Update, and System Security settings.

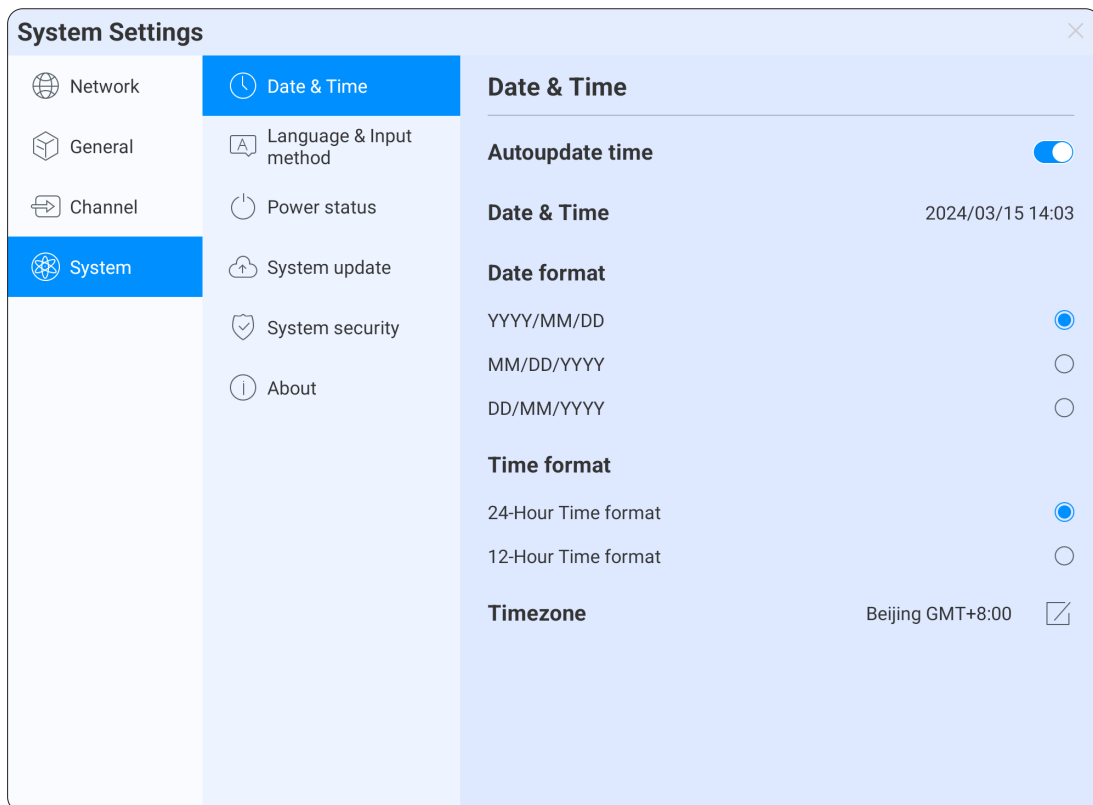

# Date & Time

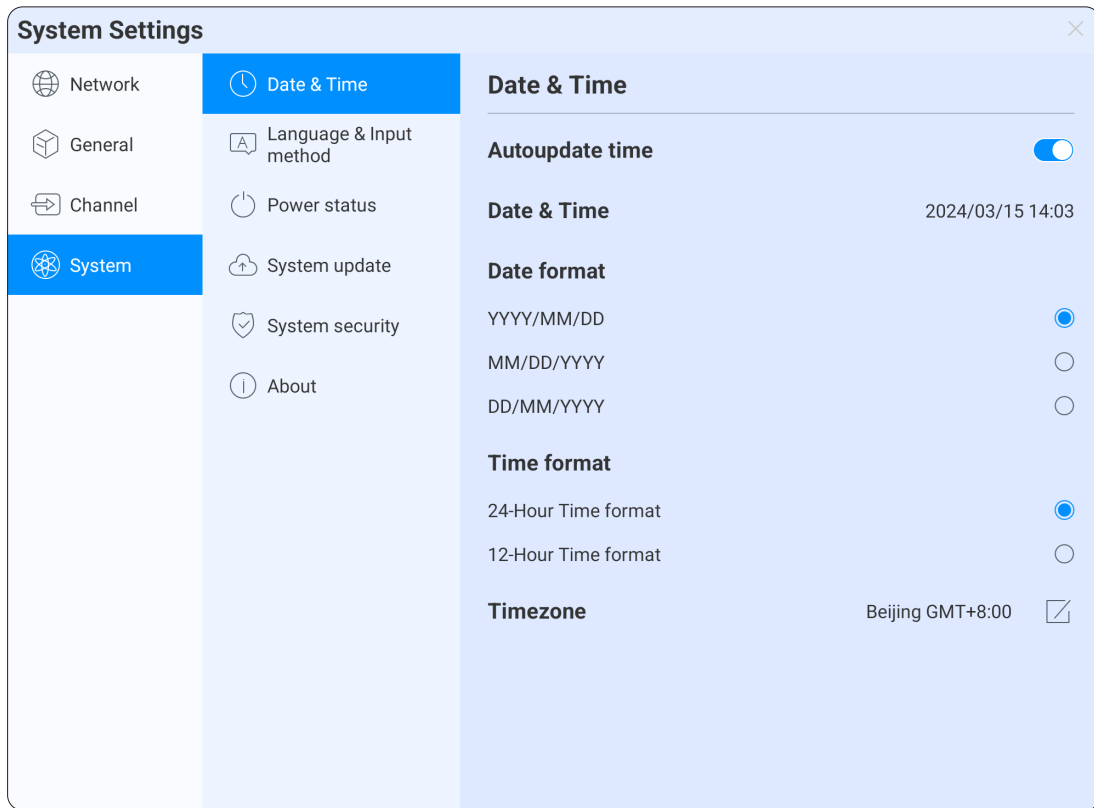

Item	Description
<b>Auto update time</b>	Automatically synchronize network time when there is an internet connection.
<b>Date &amp; Time</b>	Adjust the date and time. <b>NOTE:</b> Automatic updates need to be turned off to manually adjust the date and time.
<b>Date format</b>	Select the preferred formatting style.
<b>Time format</b>	Select between 12-hour and 24-hour format.
<b>Time zone</b>	Set the time zone.

# Language & Input Method

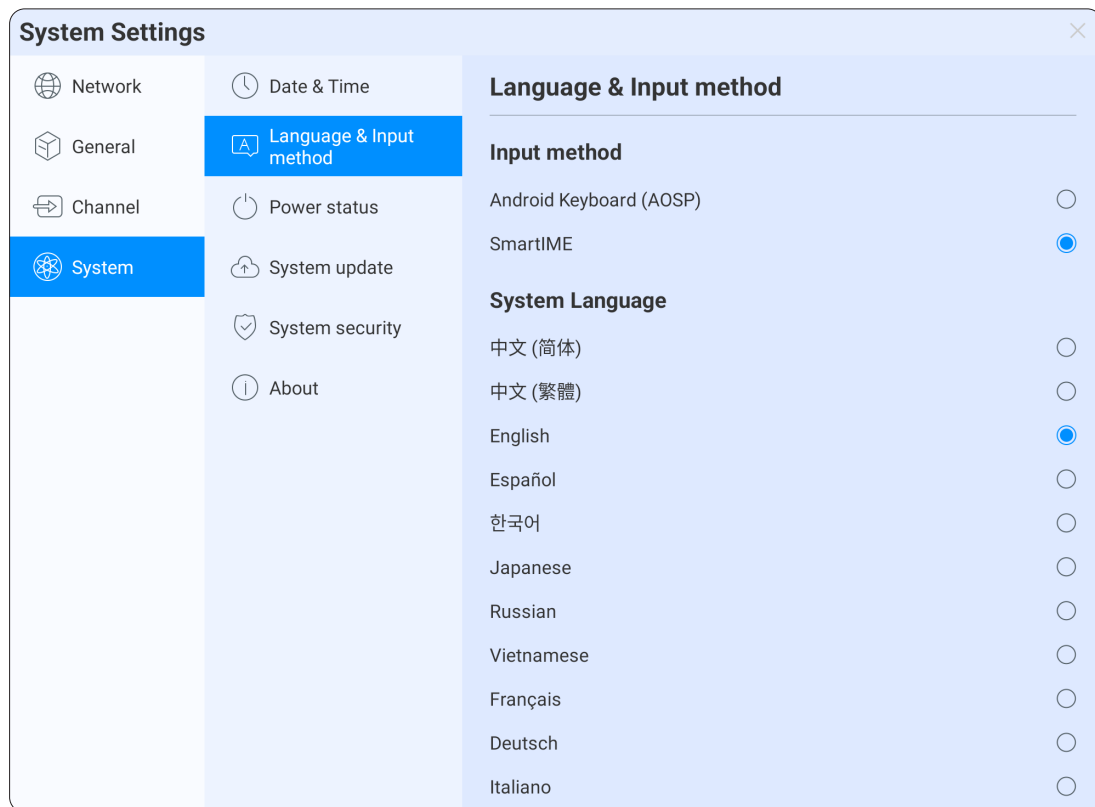

Item	Description
<b>Input method</b>	Select the preferred input method.
<b>System Language</b>	Select the preferred language for the display's system.

# Power Status

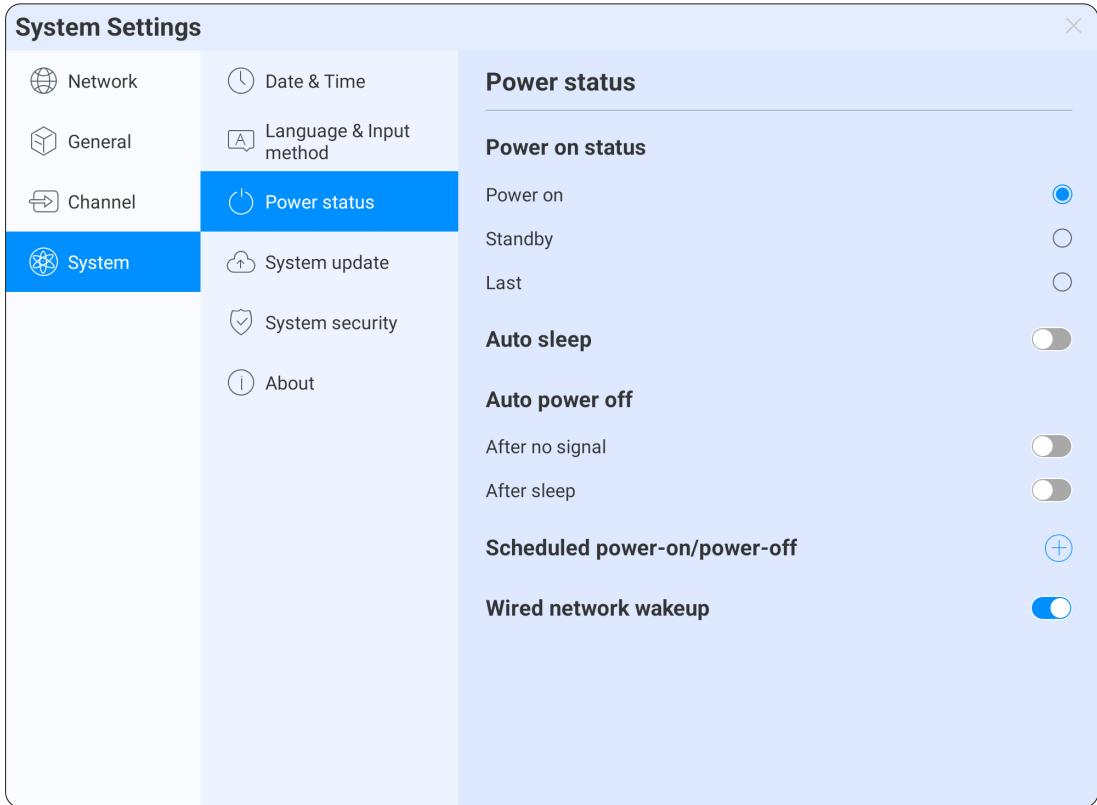

Item	Description
<b>Power on status</b>	Set the display's status after being turned on.
<b>Auto sleep</b>	When enabled, the display's screen will turn off after a set period of inactivity.
<b>Auto power off</b>	Set the display to automatically shut down after no signal or after entering sleep mode.
<b>Scheduled power-on/power-off</b>	Select the add icon  to set a power on and off time.
<b>Wired network wake up</b>	Send network messages through wired networks to turn on or wake up the display.

# System Update

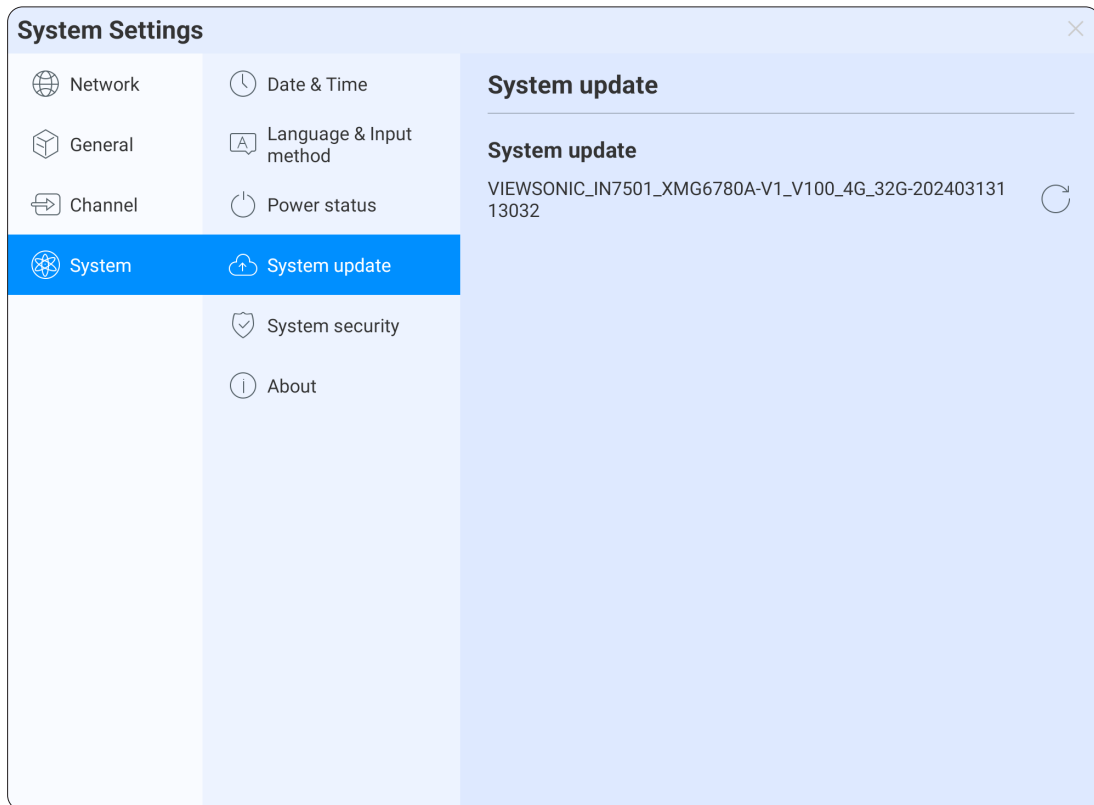

Item	Description
<b>System update</b>	Displays the current firmware version. Selecting the refresh icon will detect the latest version available. When there is a new version available, an update button will show on screen.

# System Security

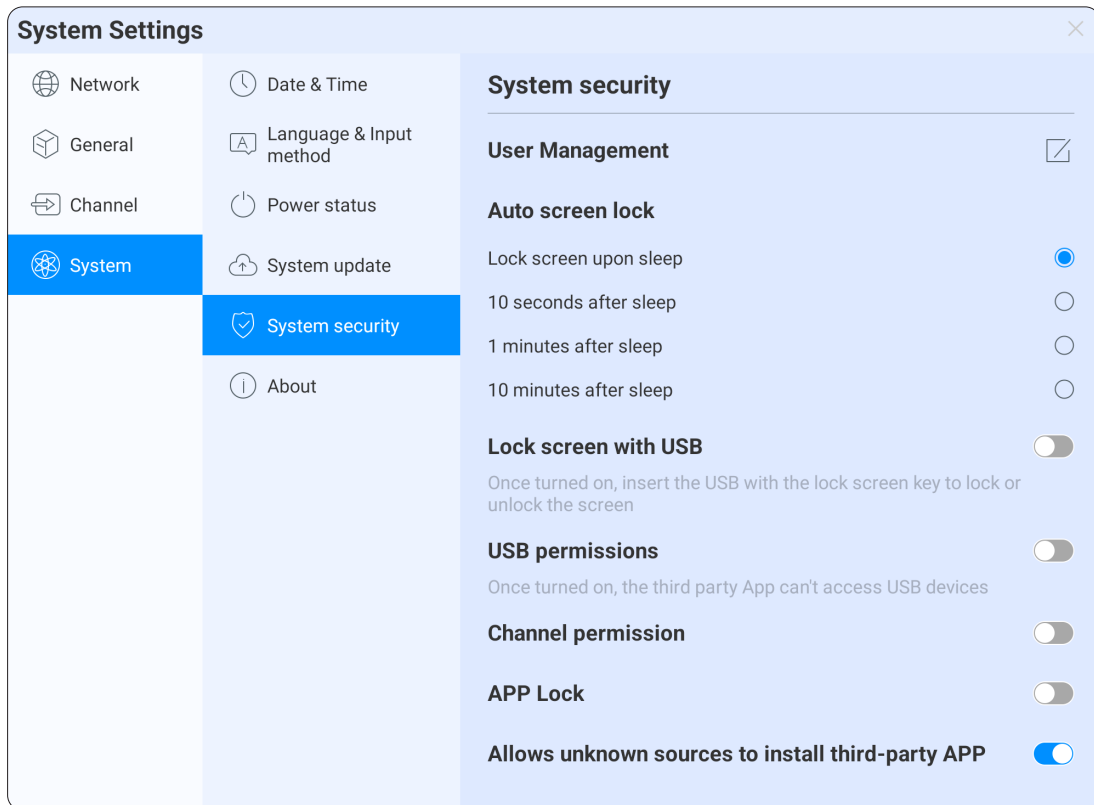

Item	Description
<b>User Management</b>	Set a pattern or password to lock the display. If you forget the password, you can only restore the display through factory reset.
<b>Auto screen lock</b>	Set the lock screen time.
<b>Lock screen with USB</b>	When enabled, insert the USB drive with the lock screen key to lock or unlock the display's screen. <u>To create a USB lock:</u> <ol style="list-style-type: none"> <li>1. Create a new text document.</li> <li>2. Enter <b>U2FsdGVkX19eyanxj43a24KpK3kZmzB9</b>. Save and name the file: <b>usb_key</b> in the root directory of the USB drive.</li> <li>3. Remove the file extension .txt and make sure the file character is UTF-8.</li> <li>4. Insert the USB flash drive to unlock the screen when it is locked.</li> </ol>
<b>USB permissions</b>	When enabled, third-party applications cannot access USB devices.
<b>Channel permission</b>	When enabled, you can set a four digit password that must be entered when entering a channel.
<b>App Lock</b>	When enabled, you can lock applications. To open a locked application you will need to enter a password.

<b>Item</b>	<b>Description</b>
<b>Allows unknown sources to install third-party App</b>	Allow installation of applications from unknown sources.

# About

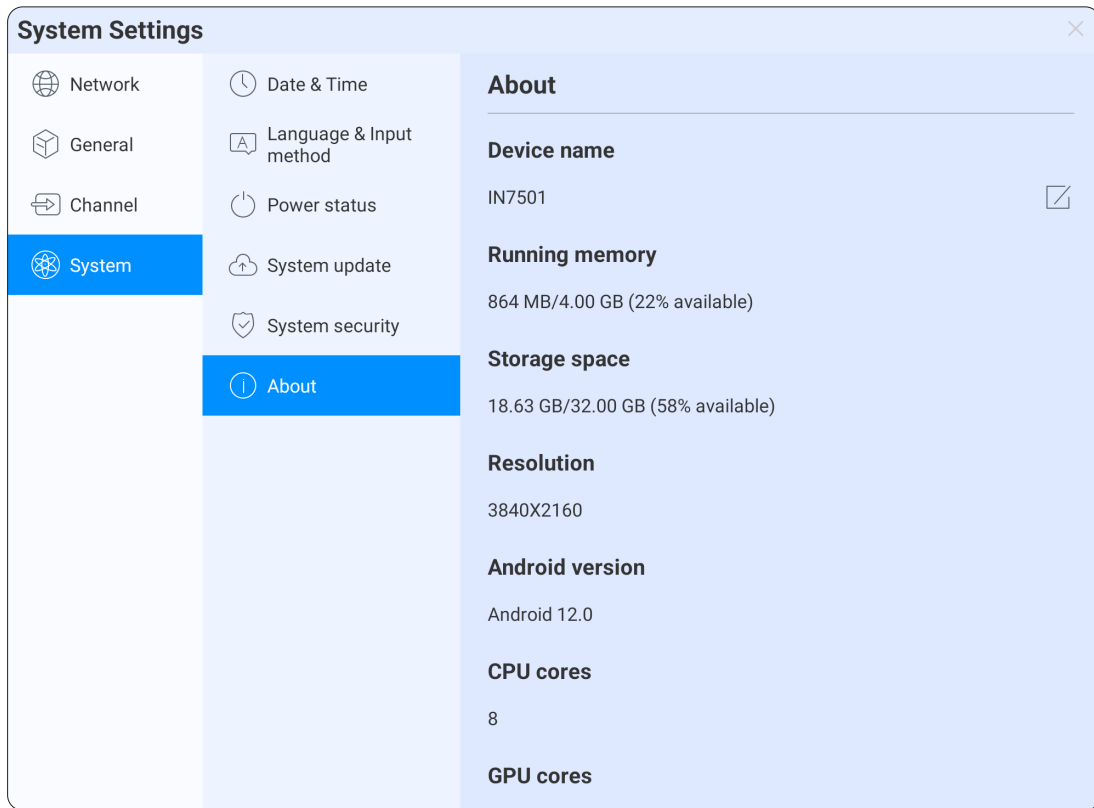

Item	Description
<b>Device name</b>	Edit the name of the display.
<b>Running memory</b>	Shows the used memory and total memory ratio.
<b>Storage space</b>	Shows the used storage and total storage ratio.
<b>Resolution</b>	Shows the display's current resolution.
<b>Android version</b>	Shows the current version of Android.
<b>CPU cores</b>	Shows the total number of CPU cores.
<b>GPU cores</b>	Shows the total number of GPU cores.
<b>MAC address</b>	Shows the display's LAN MAC address.
<b>Up time</b>	Shows the total running time of the display.
<b>Restore default settings</b>	Restore the display to its factory state, deleting all content.
<b>SN</b>	The serial number of the display.

# Pre-installed Applications and Settings

## EShare

EShare is a full-featured multi-screen interactive software designed for casting, wireless display, and remote control between mobile devices (e.g., phones, tablets, laptops, etc.) and large format displays.

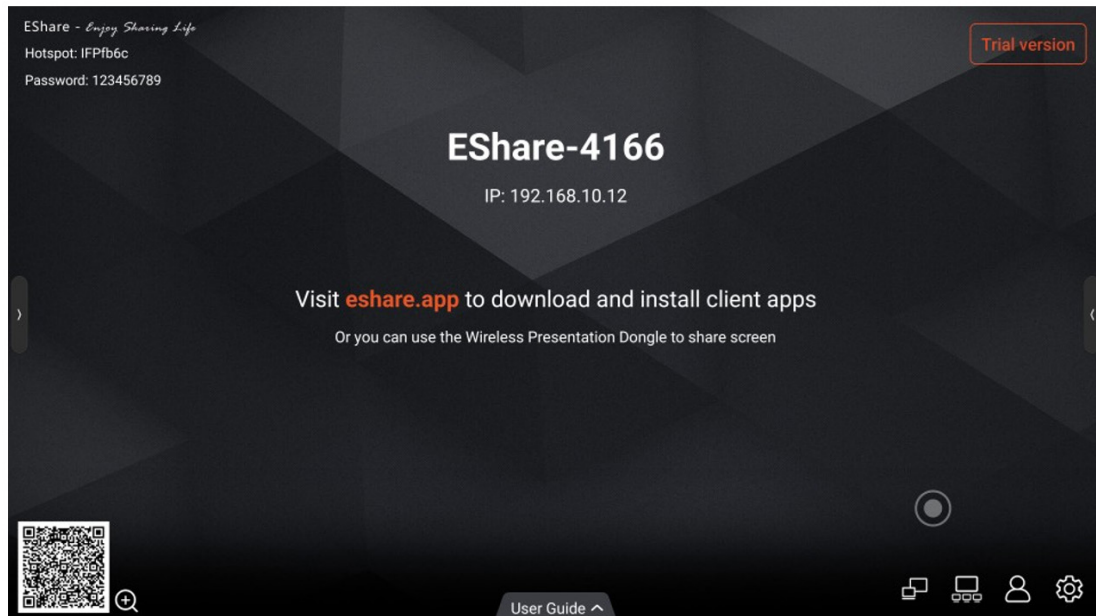

## Key Features

Item	Description
<b>Mirroring</b>	Mirror client device screens (supporting iPhone, iPad, Android, MacBook, Chromebook, Windows, Ubuntu, etc.) to the display, and use touch control on the display to wirelessly control client devices.
<b>File Casting</b>	Share files (such as audio, video, photo, office document, PDF, etc.) from phones or tablets to the display.
<b>Remote Control</b>	Supports wireless control via wireless mouse, air mouse, keyboard, touch pad, etc.
<b>Camera</b>	Cast the camera or microphone to a display in real-time.
<b>Wireless Annotations</b>	Annotate the display with client applications in real-time.
<b>TV Mirror</b>	Mirror the display to multiple client devices, and allow touch control of the display wirelessly from a laptop or phone.
<b>Multiple Screens</b>	Cast multiple device screens to a display simultaneously and the display's screen will be split automatically.
<b>Display Group</b>	Duplicate the main display or the casting screen to all grouped displays.
<b>Moderator Mode</b>	The moderator can determine what client devices to mirror, annotate, etc.
<b>AirPlay</b>	Compatible with the AirPlay feature of Apple devices.
<b>DLNA</b>	Supports any application compatible with the DLNA protocol.
<b>Miracast</b>	Supports screen casting and touch feedback for Windows laptops or Android phones that are compatible with the Miracast protocol.
<b>Chromecast</b>	Supports direct casting from the Google Chrome browser, ChromeOS devices, YouTube application and Android phones.
<b>WebCast</b>	Share screens through a web browser on the laptop without installing any applications when enabled.

## Device Requirements

- Android 5.0 or later
- MacOS 10.9 or later
- iOS 9.0 or later
- Windows 7/8/10/11
- ChromeOS
- Ubuntu 12.04 or later

## Network Requirements

When using EShare on your network, please use the below ports.

Port	Type	Service or Protocol	Used By
80/443	TCP	Hypertext Transfer Protocol (HTTP, HTTPS) <b>Destination:</b> casts.app gw.casts.app h1.ee-share.com	WebCast
1900	UDP	Simple Service Discovery Protocol (SSDP)	Bonjour
51010-51060	TCP	EShare Proprietary	EShare Apps, AirPlay
8121, 57395, 8080, 52025, 8600	TCP	EShare Proprietary	EShare Apps
48689	UDP	Device Discovery	EShare Apps
5353	UDP	Multicast DNS (MDNS)	Bonjour, AirPlay
10000-65535	UDP	DTLS <b>Destination:</b> DNS: *.casts.app IPV4: 3.124.195.37 54.169.2.51 64.64.232.232 119.28.92.194 106.55.235.101	WebCast
8008, 8009	TCP	GoogleCast Proprietary	ChromeCast

## Bandwidth Requirements

Item	Description
<b>Mirroring</b> (from laptop or phone to display)	The maximum bit rate can be as high as 30 Mbps, but average bit rates will be significantly lower. For best results, it is recommended to use an Ethernet connection with the display and a 5 GHz Wi-Fi connection for laptops/phones.
<b>TV Mirror and Display Group</b>	The average bit rates of TV Mirror and Display Group are 4 Mbps. Please reserve bandwidth accordingly. For example, if there are 40 tablets or laptops in the classroom using TV Mirror, the required bandwidth could be calculated as 40 x 4 Mbps = 160 Mbps.
<b>WebCast</b>	The average bit rates of each WebCast connection are 4~5 Mbps. It's recommended to reserve a steady 5 Mbps bandwidth for each WebCast.

# EShare Application

## Download the EShare Application

**NOTE:** Please make sure the client device (e.g., phone, laptop, etc.) is connected to the same network as the display.

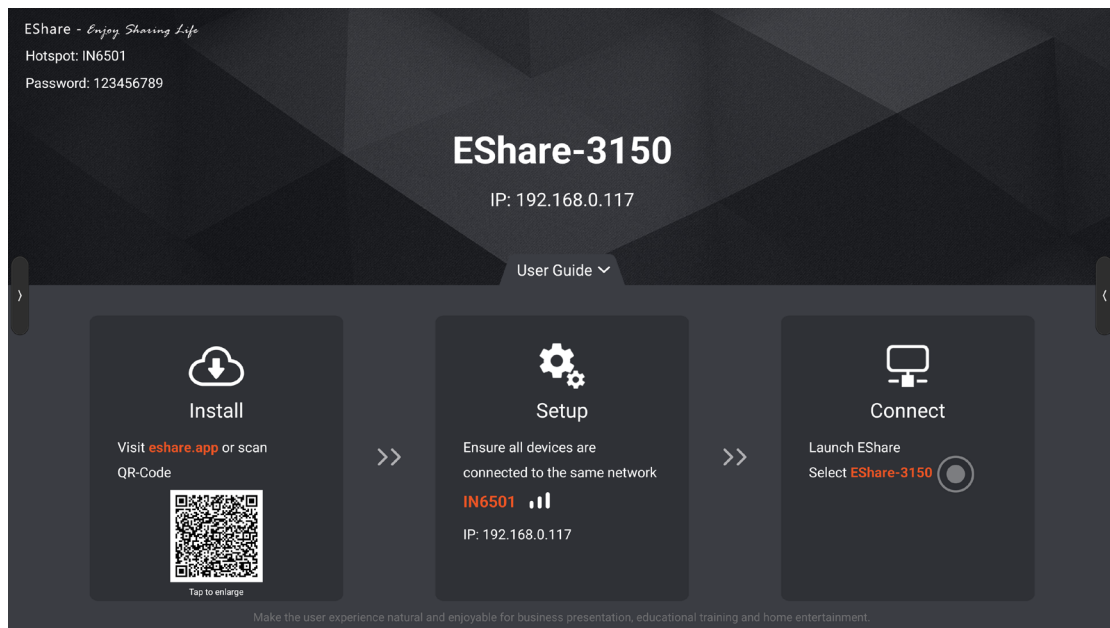

1. On the display, launch the ESharePro application.
2. On the client device, scan the QR code or go to: [eshare.app](https://eshare.app).
3. Download and install the Eshare application onto the client device.

## For Android/iOS Devices

**NOTE:** Please make sure the client device (e.g., phone) is connected to the same network as the display.

### Connecting to the Display

There are four ways to connect the client device to the display.

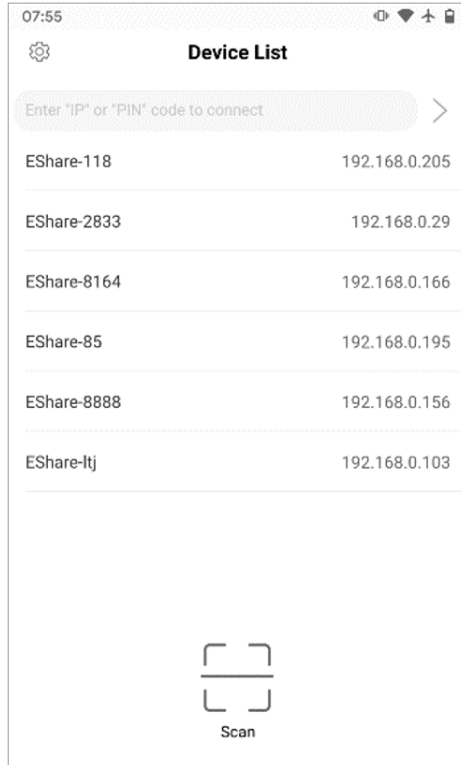

Connection Method	Description
<b>Device Name</b> (Default Setting)	Select the display's name from the Device List.
<b>PIN Code</b>	Enter the PIN code found on the display.
<b>Enter IP Address</b>	Enter the IP address found on the display.
<b>Scan QR Code</b>	Scan the QR code found on the display.

# File Sharing

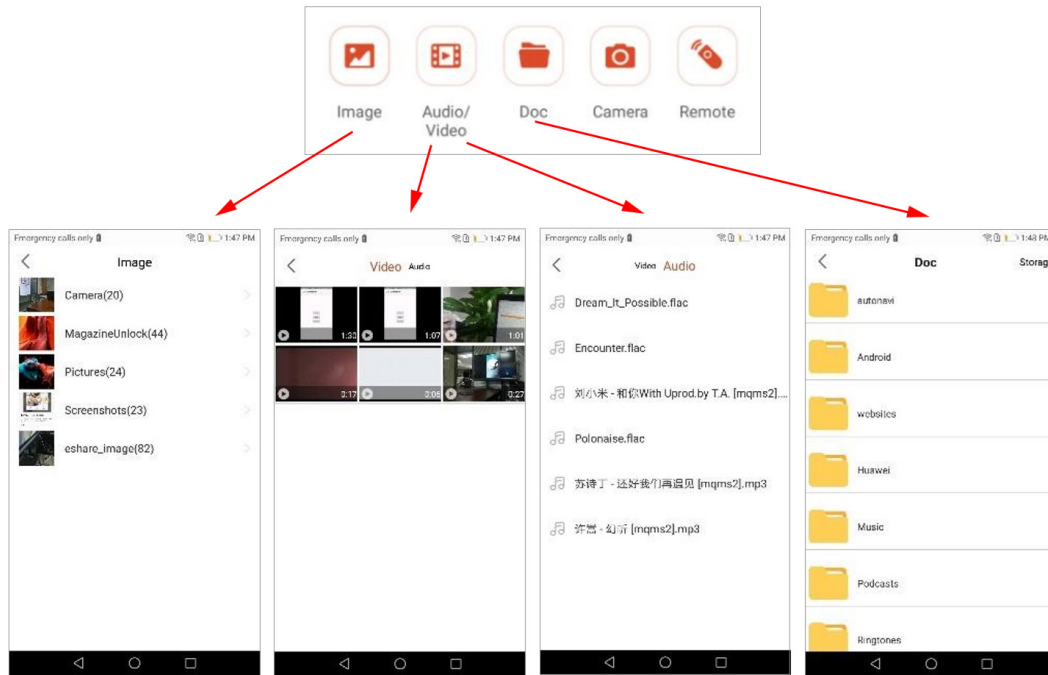

Item	Description
<b>Image</b>	Select any image file to share to the display.
<b>Audio/Video</b>	Select any audio/video file to share to the display.
<b>Doc</b>	Select any document (e.g., Word, PPT, Excel, TXT, etc.) to share to the display.
<b>Storage</b>	Select <b>Storage</b> in the top right corner of the Doc sharing page to enable wireless storage, then visit the URL shown on the client device to upload or download files from storage.

## Screen Sharing

- Android Devices

Select **Share Screen** to share the client device's screen to the display.



- iOS Devices

Select **Share Screen** then follow the iOS screen sharing guide to share the client device's screen to the display.

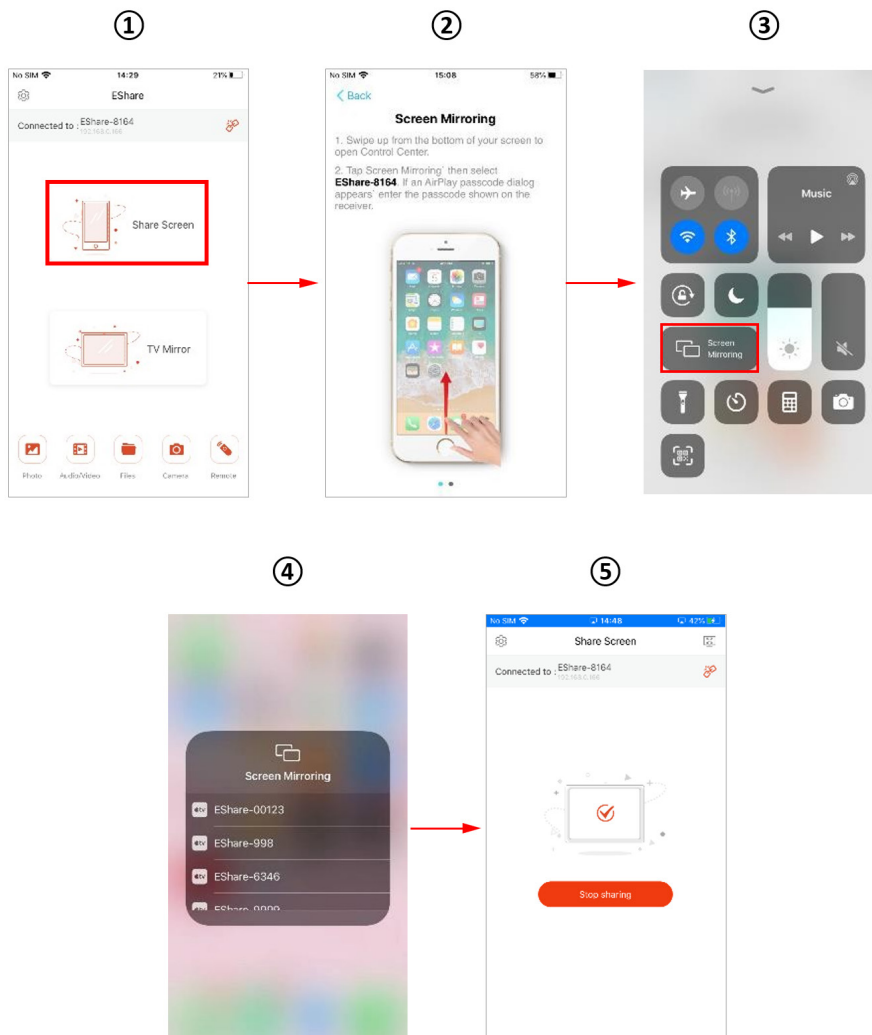

## Full Screen

If two or more client devices are sharing the display's screen, selecting **Full-Screen** will display a single client device's screen only.

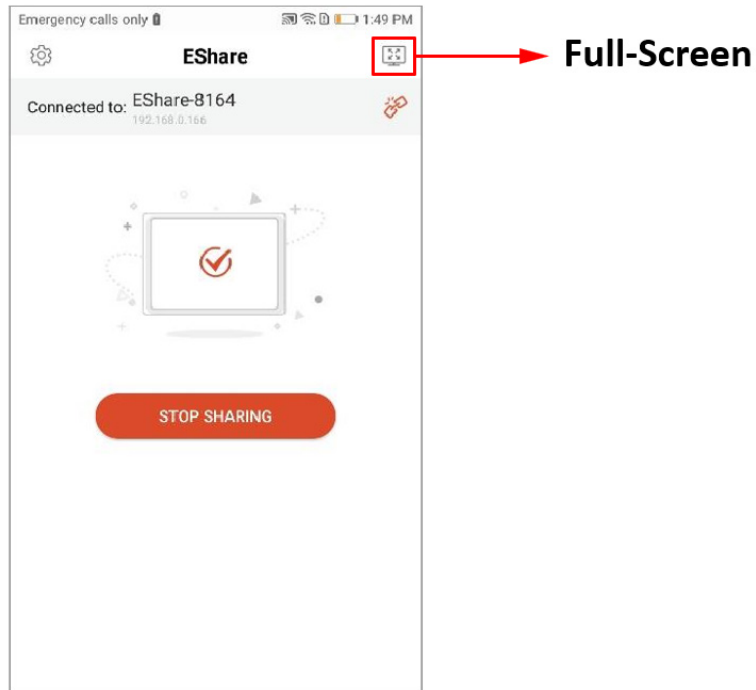

## TV Mirror

Select **TV Mirror** to mirror the screen of the display to the client device and control it.

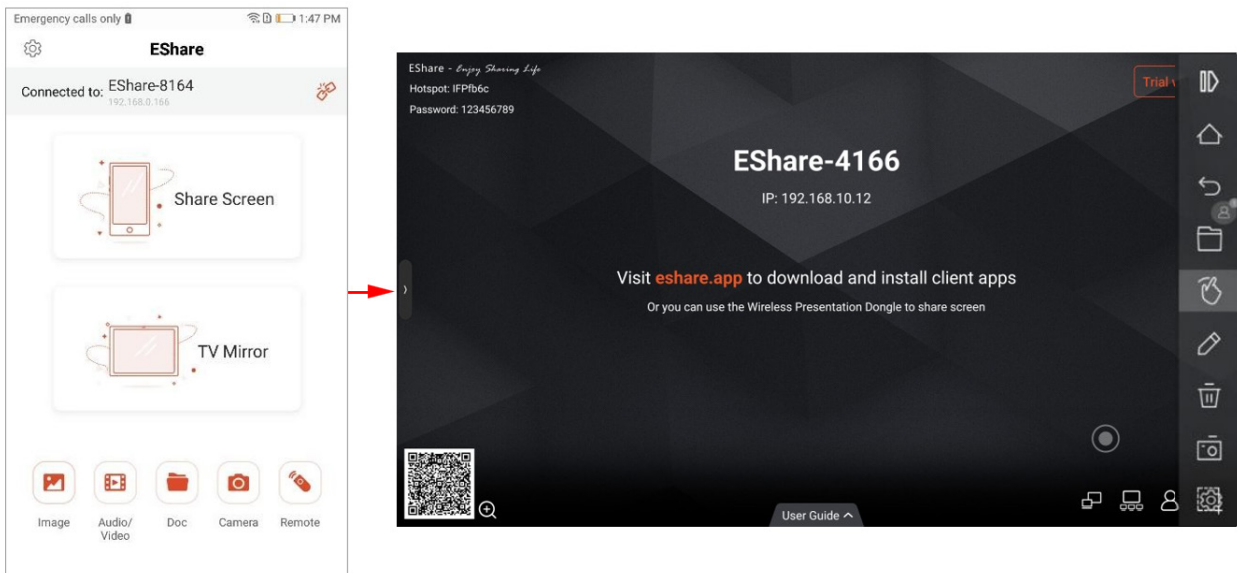

## Wireless Annotations

After selecting **TV Mirror**, select the pen icon to start wireless annotation on the display.

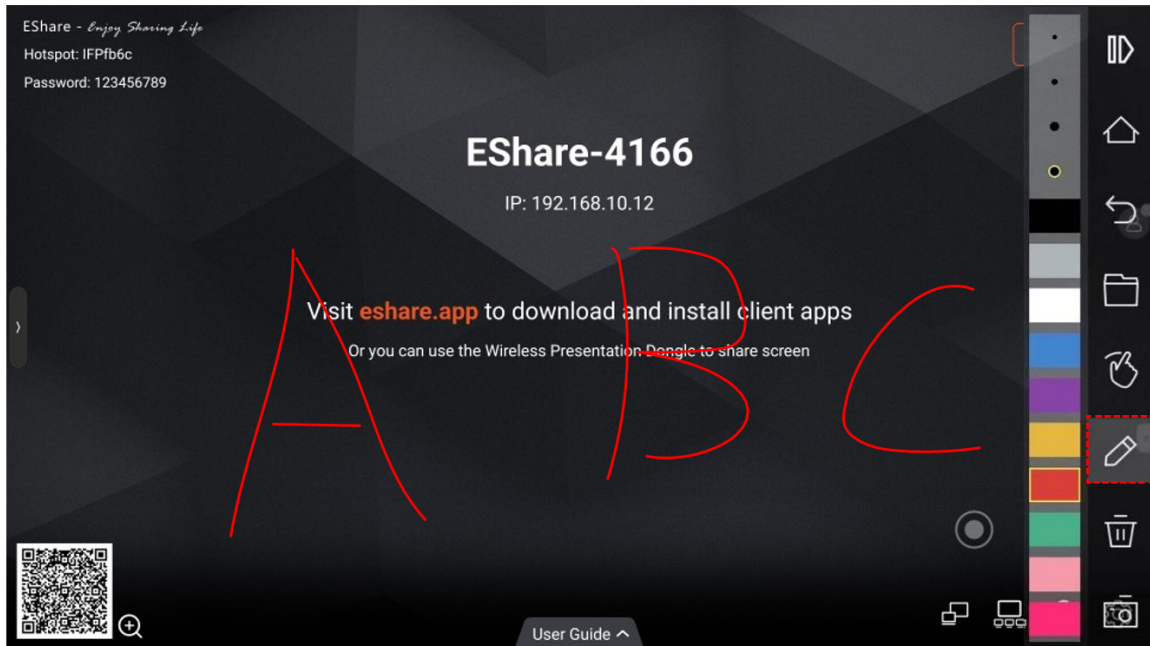

## Camera

Select **Camera** to share photos or audio from your client device's camera or microphone to the display in real-time.

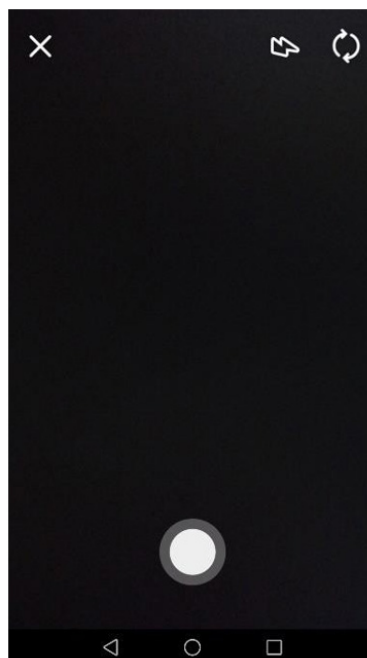

## Remote Control

Select **Remote** to use the client device as a wireless mouse, remote control, keyboard, etc.

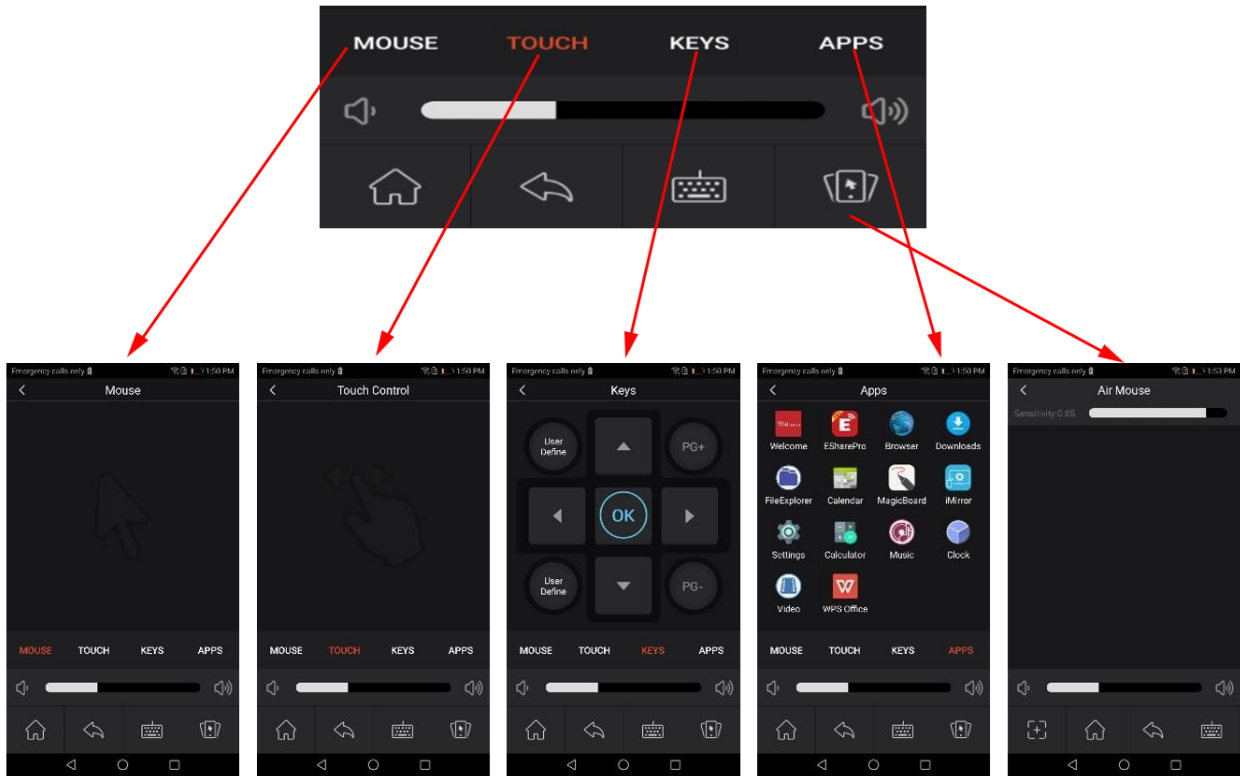

## Share Files from Other Applications to the Display

In email, browser, file manager, and other applications, you can share files to the display through the EShare application or you can share files to the display with other applications supporting DLNA.

## For Windows/macOS/ChromeOS/Ubuntu Devices

**NOTE:** Please make sure the client device (e.g., laptop) is connected to the same network as the display.

### Connecting to the Display

There are four ways to connect the client device to the display.

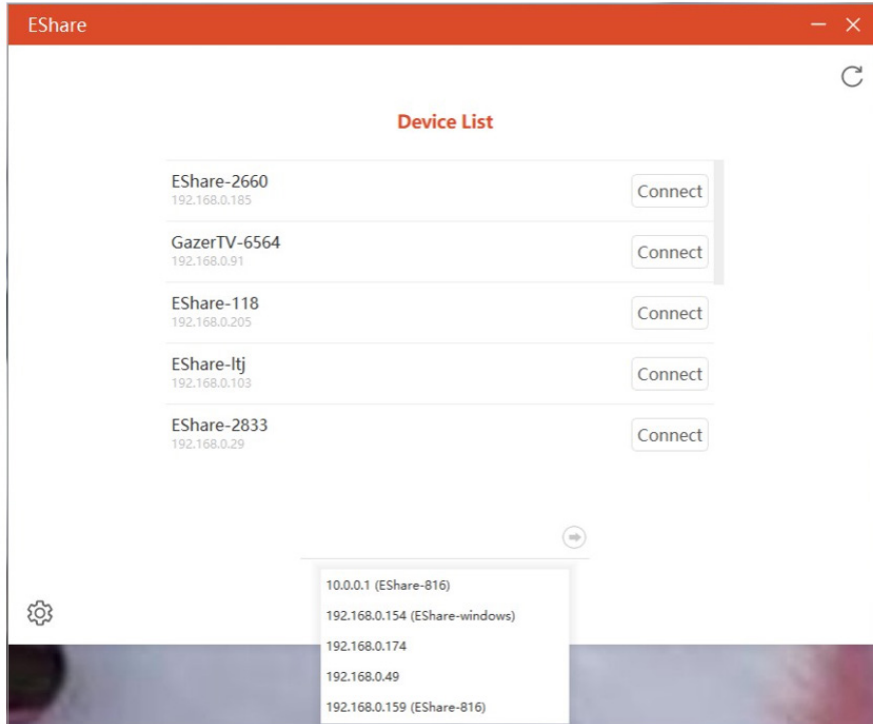

Connection Method	Description
<b>Device Name</b> (Default Setting)	Select the display's name from the Device List.
<b>PIN Code</b>	Enter the PIN code found on the display.
<b>Enter IP Address</b>	Enter the IP address found on the display.
<b>Select the Device in the History List</b>	Click the input box "Enter IP or PIN code to connect" and a history list will appear (if applicable). Select the display to connect to.

## Screen Sharing

Select **Share Screen** to share the client device's screen to the display.

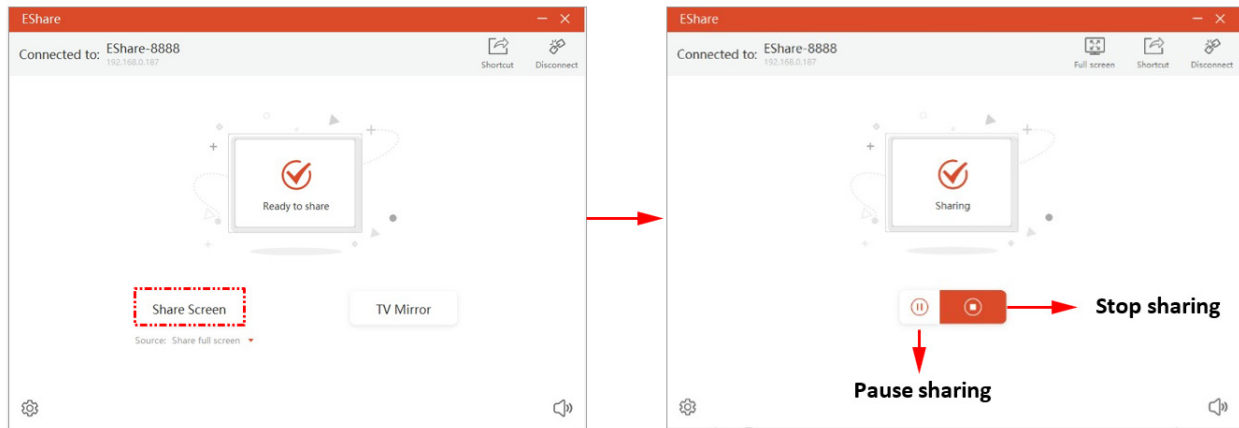

## Extend Screen

**NOTE:** Only for Windows 10 1607 or later.

For Windows users, an extended screen can be shared by selecting **Source** then **Share extend screen**.

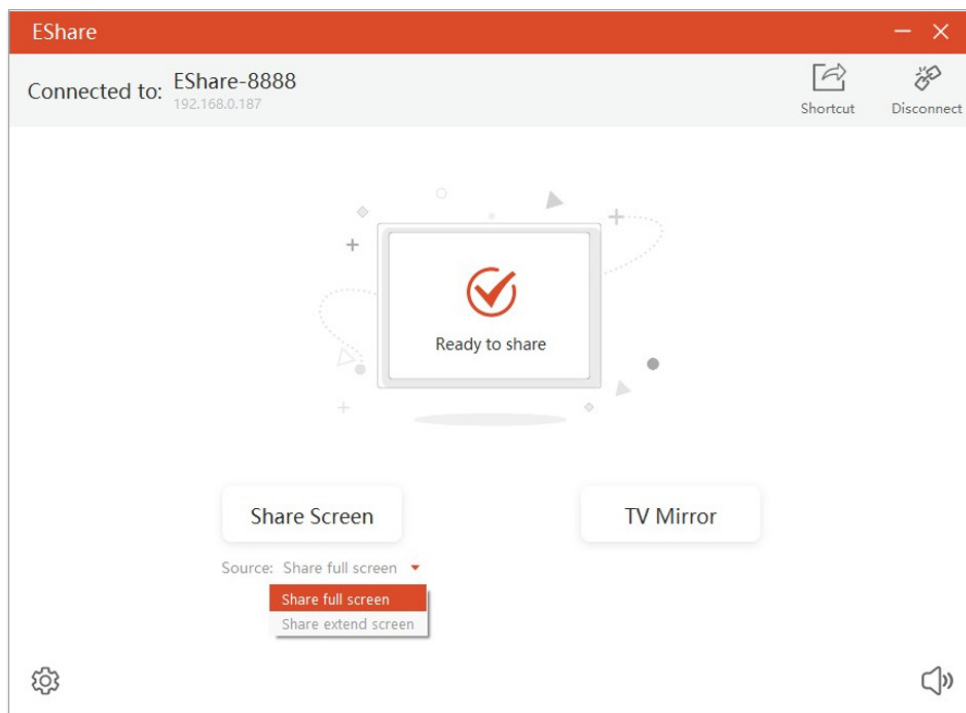

## Desktop Shortcut for Quick Screen Sharing

**NOTE:** Only for Windows devices.

Once the client device is connected to the display, select **Shortcut** to create a desktop shortcut on the client device that will quickly share the client device's screen when selected.

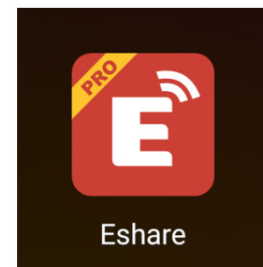
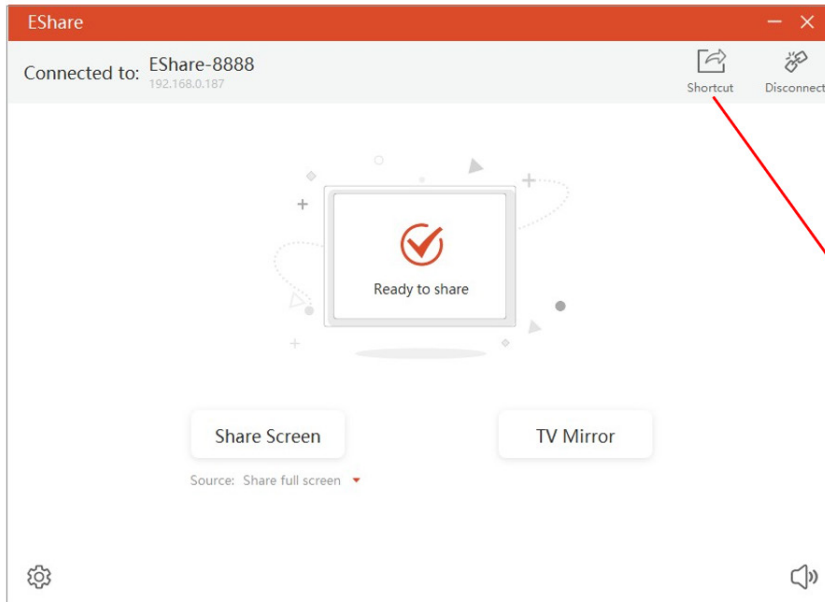

## TV Mirror

Select **TV Mirror** to mirror the screen of the display to the client device and control it.

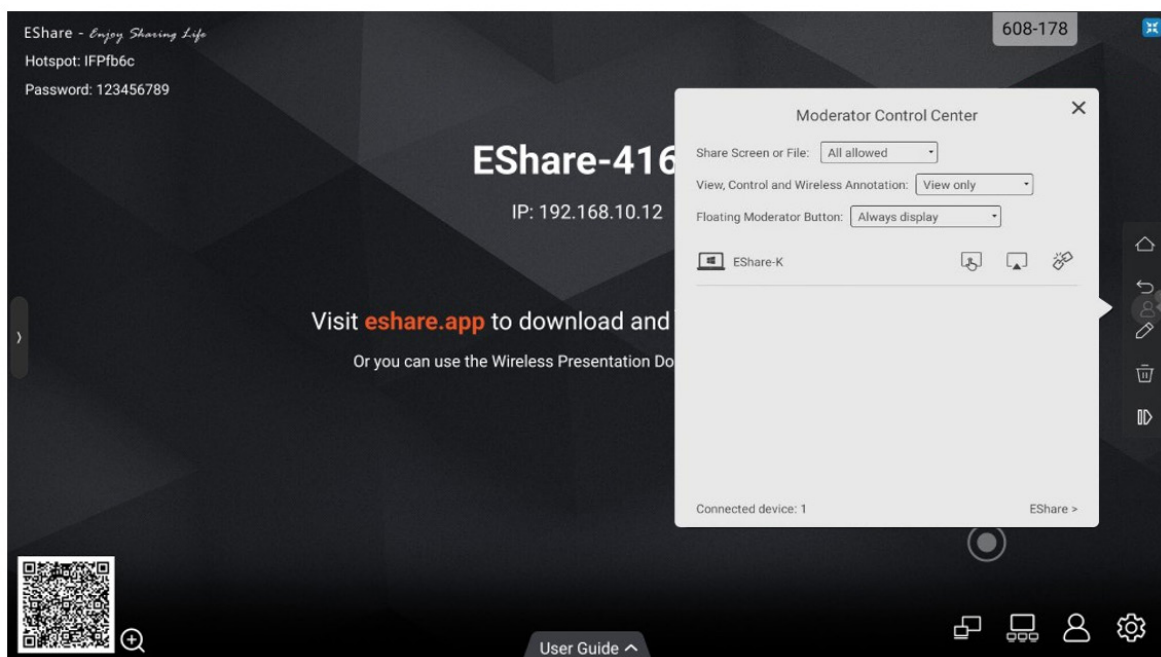

## Wireless Annotations

After selecting **TV Mirror**, select the pen icon to start wireless annotation on the display.

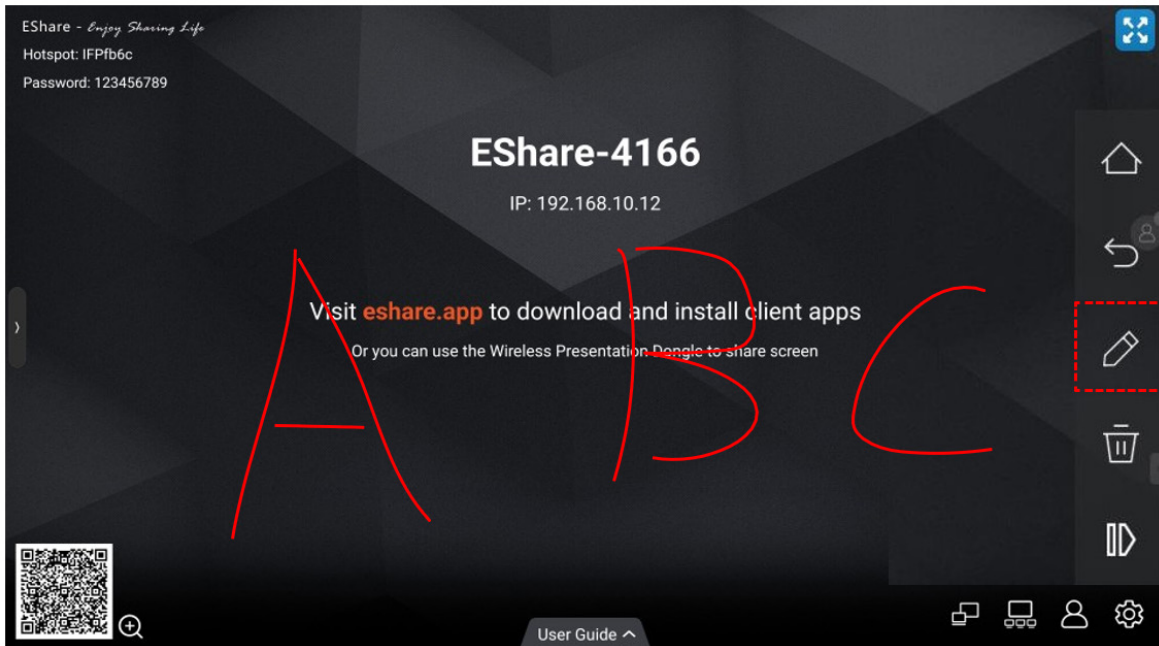

## Full Screen

If two or more client devices are sharing the display's screen, selecting **Full-Screen** will display a single client device's screen only.

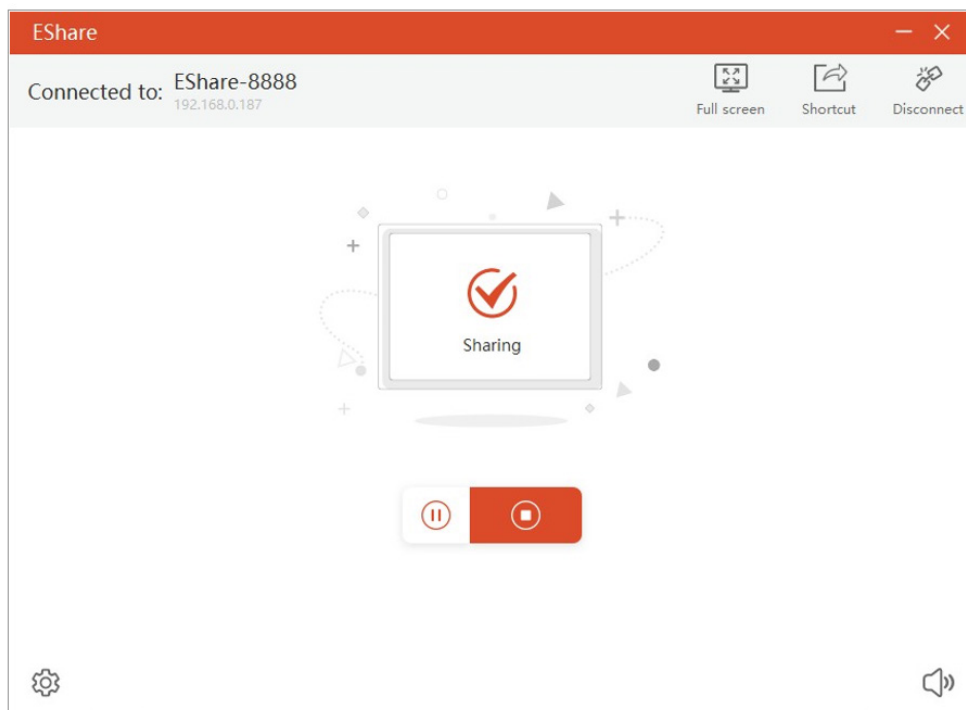

## Invitation for Mirroring

Set the preference for when a moderator sends an invitation for screen sharing.

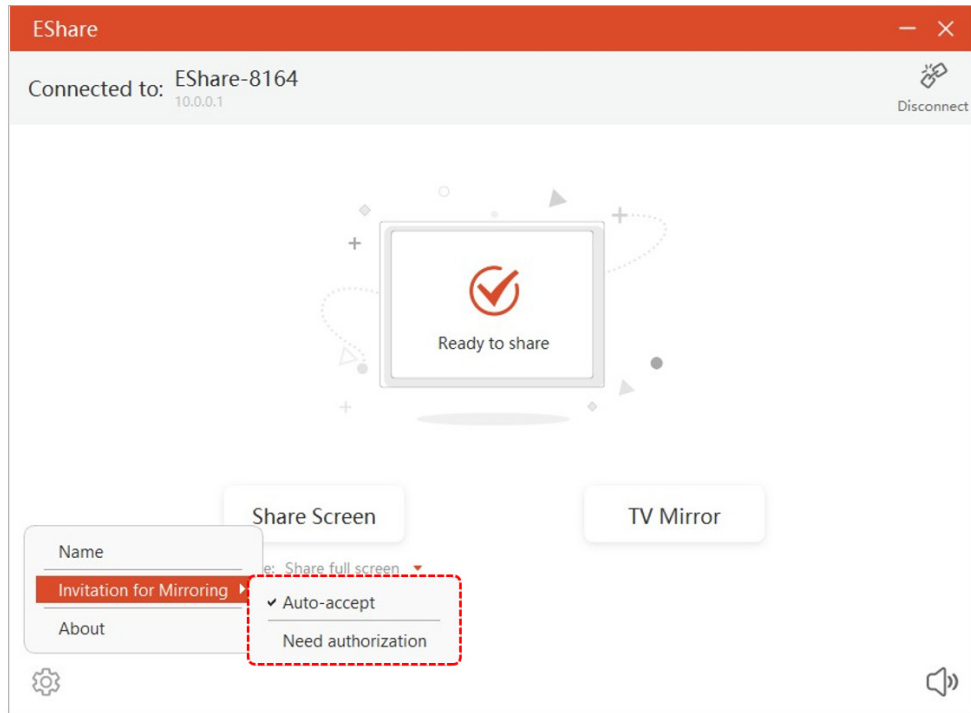

Item	Description
<b>Auto-accept</b>	Automatically accept the invitation. When the Moderator selects <b>Screen Share</b> in the Moderator Control Center, the client device's screen will be shared on the display.
<b>Need authorization</b>	When the Moderator selects <b>Screen Share</b> in the Moderator Control Center, the client device's screen will not be shared until the invitation is accepted.

# EShare Pro Receiver

## Key Features

The main page of EShare Pro Receiver will show the network name, QR code, device name, IP address, and user guide. In the bottom right are the Display Group, Moderator Control Center, and Settings.

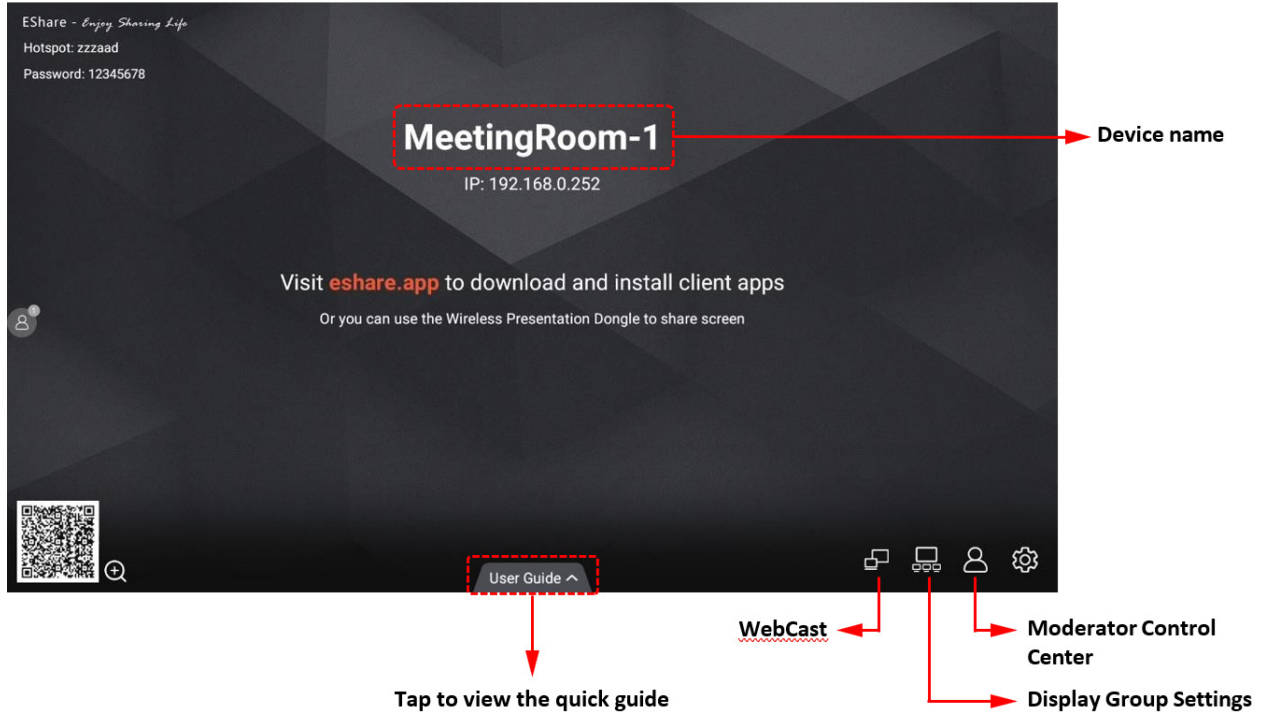

## Settings

Adjust the Device Name, Connection Mode, Multiple Screens, and other settings.



Item	Description
<b>Show Device Name on Screen</b>	When enabled, the client device's name will be shown in the top left of the display.
<b>Auto Full Screen</b>	When enabled, the client device's screen will cover the entire display screen.
<b>AirPlay Visible</b>	When enabled, iOS and macOS devices can share their screen with AirPlay directly. If disabled, the devices will need to use EShare client applications.
<b>Miracast</b>	When enabled, supported devices can share their screen with Miracast directly. If disabled, the devices will need to use EShare client applications.
<b>Chromecast</b>	When enabled, supported devices can share their screen with Chromecast directly. If disabled, the devices will need to use EShare client applications.

## Multiple Screens

### Multiple Screens Setting

Select the **Settings** icon to set the number of Multiple Screens.

**NOTE:** A maximum of nine screens can be set.

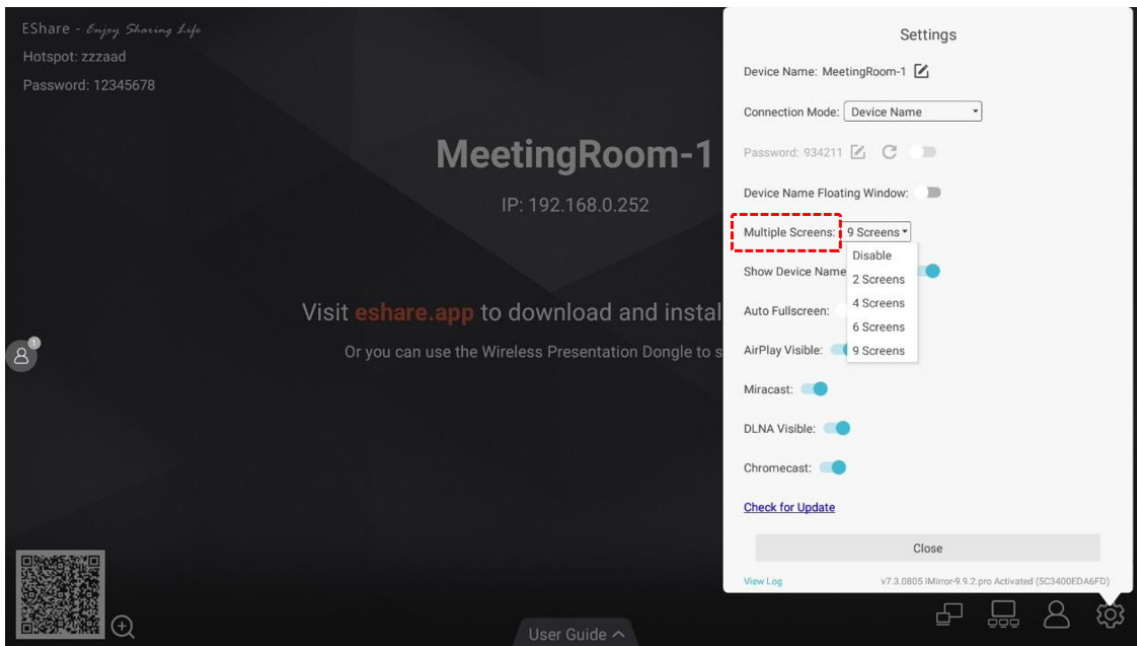

### Multiple Screens Display

Multiple client device screens can be shared to the display at the same time and the display screen will be split automatically.

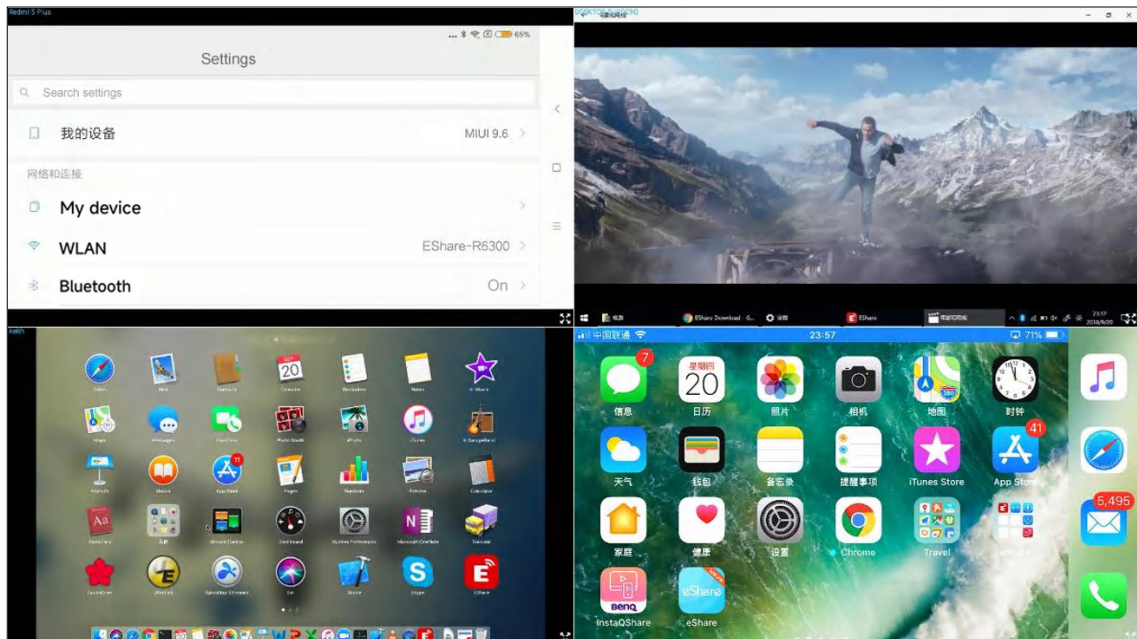

## Switch the Audio Source

The audio of the last sharing device will be output by default from the display when in Multiple Screen mode. Selecting any one of the split windows on the display will change the audio output source.

**NOTE:** For Android phones with Android 10.0 or later, audio can be played through the display while mirroring only if the other applications allow their audio to be recorded. For Android 9.0 or before, the audio cannot be casted as Google doesn't share the API needed for audio casting. The audio of those Android phones while screen sharing will only be output from the phone.

## Full Screen or Multiple Screens

Select the **Full Screen** icon at the bottom right of the display when in Multiple Screen mode to change the aspect ratio to full screen. Select the icon again to exit Full Screen mode and go back to Multiple Screen mode.

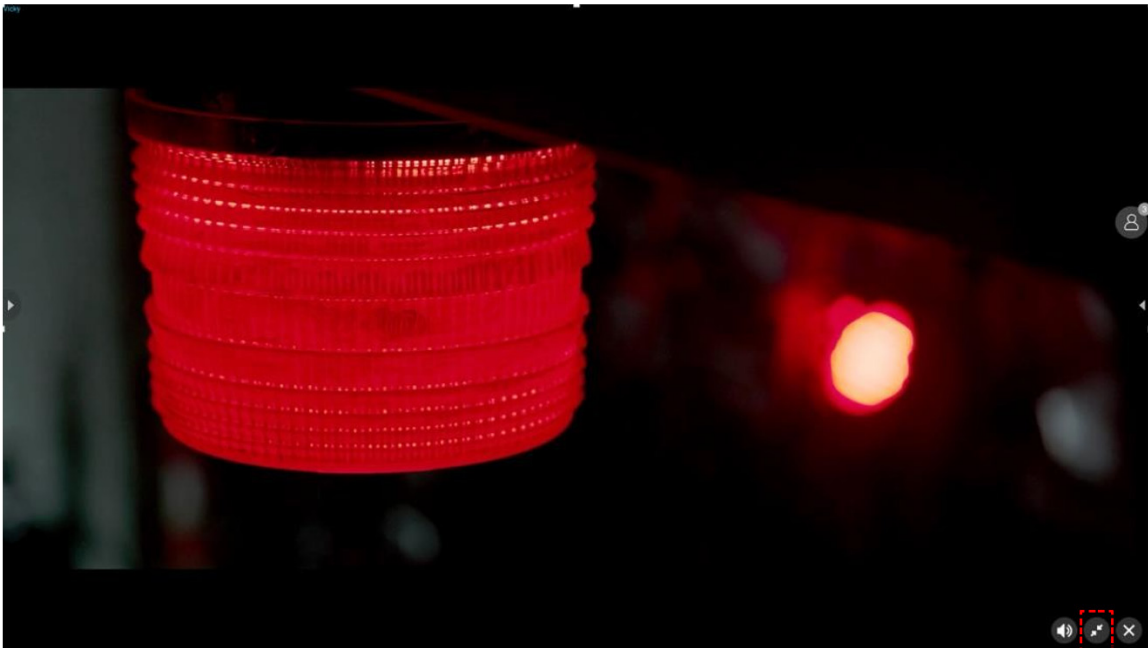

## Display Group

The main screen can be duplicated to multiple displays simultaneously, and the client device can also be mirrored to multiple receiver displays.

**NOTE:** EShare Pro must be installed and activated and the devices are on the same Local Area Network (LAN).

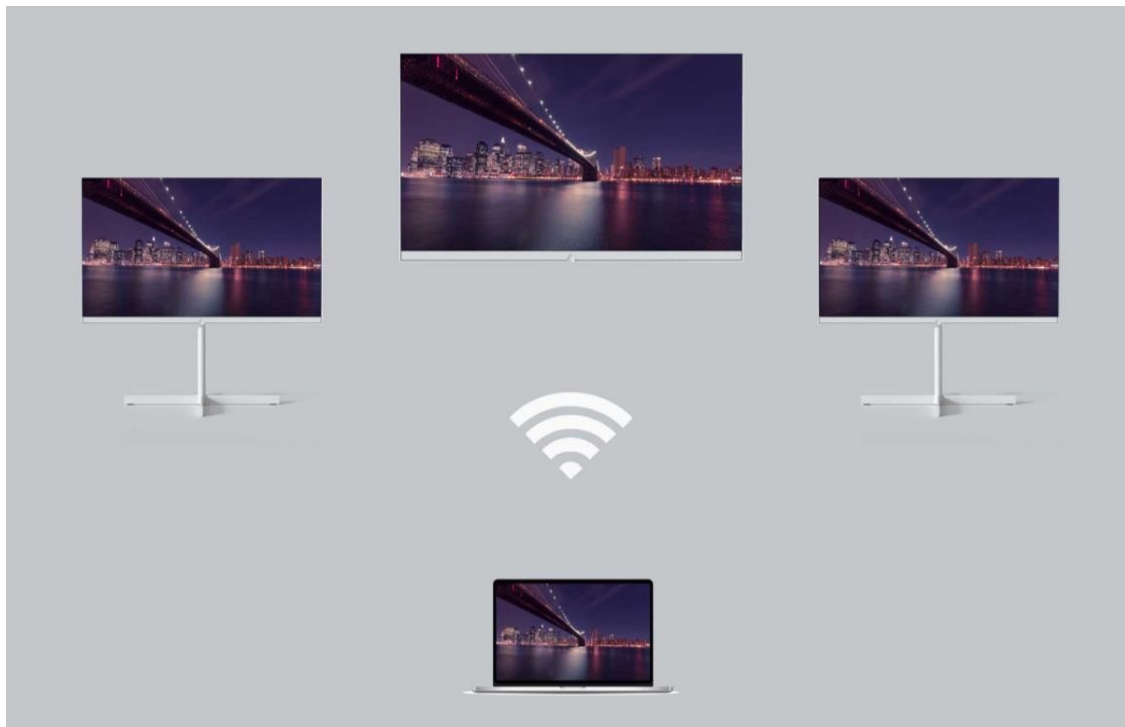

## Options for Duplicate Displays

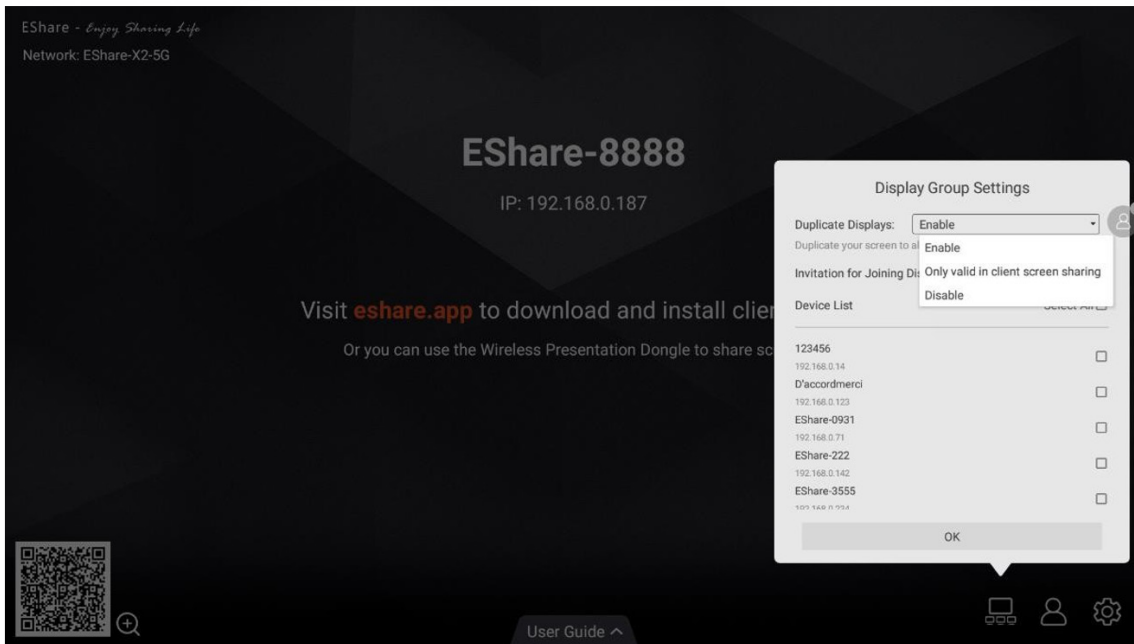

Item	Description
<b>Enable</b>	Other EShare Pro preinstalled displays in the same network (if any) will be listed. Select a display to add to the display group, then select <b>OK</b> to apply the settings.
<b>Only valid in client screen sharing</b>	Only when the sender is casting a screen, will the devices in the display group be synchronized to the display.
<b>Disable</b>	Disable the Display Group feature.

## Options for Invitation

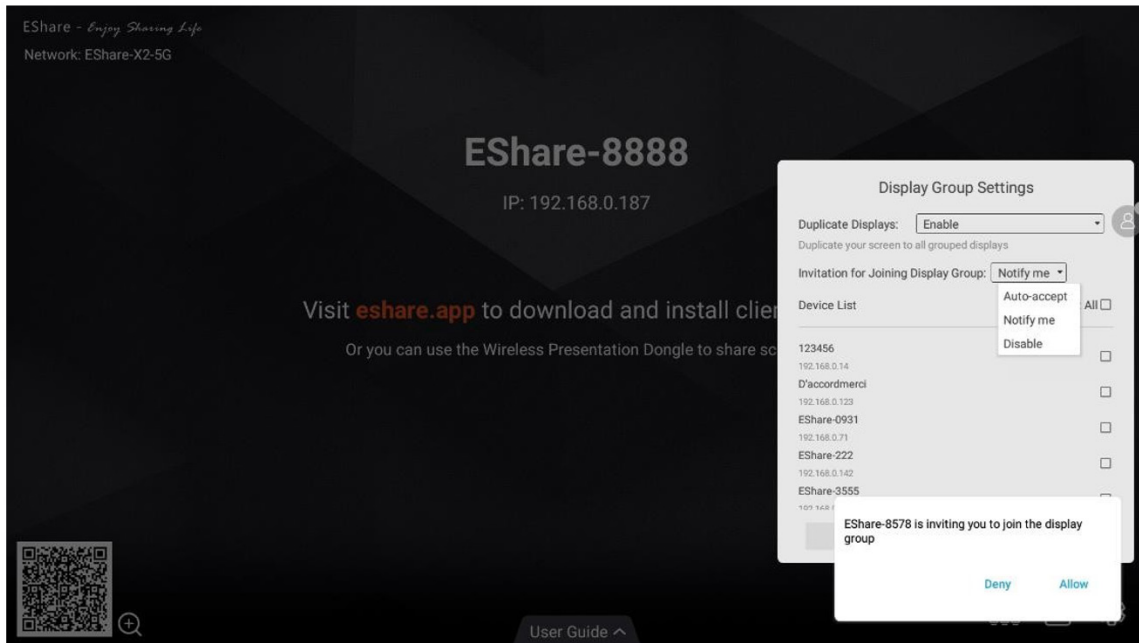

Item	Description
<b>Auto-accept</b>	Other displays can share their screen to this display without any permissions.
<b>Notify me</b>	You will see a dialog box when your screen is invited to join the group, and other displays can share their screen to this display only when you allow the invitation.
<b>Disable</b>	All display group invitations will be automatically rejected.

## Moderator Control Center

Select the **Moderator Control Button** in the bottom right corner to enter the Moderator Control Center. The Moderator Control Center can also be entered by selecting the floating moderator button.

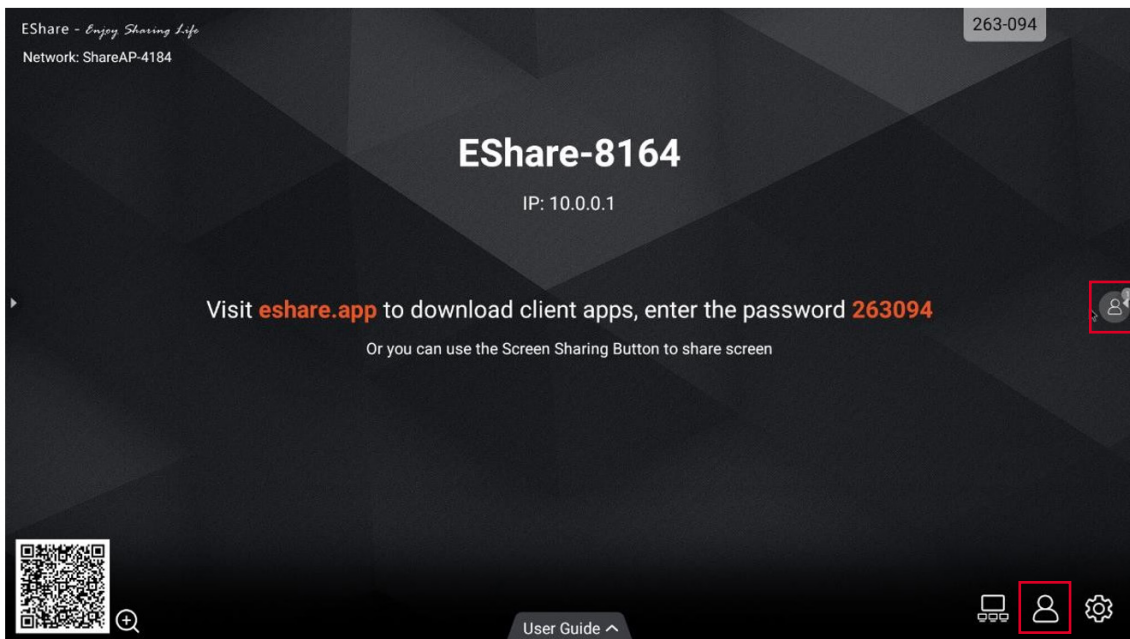

Item	Description
<b>Auto-accept</b>	Other displays can share their screen to this display without any permissions.
<b>Notify me</b>	You will see a dialog box when your screen is invited to join the group, and other displays can share their screen to this display only when you allow the invitation.
<b>Disable</b>	All display group invitations will be automatically rejected.

## Options for Screen Sharing

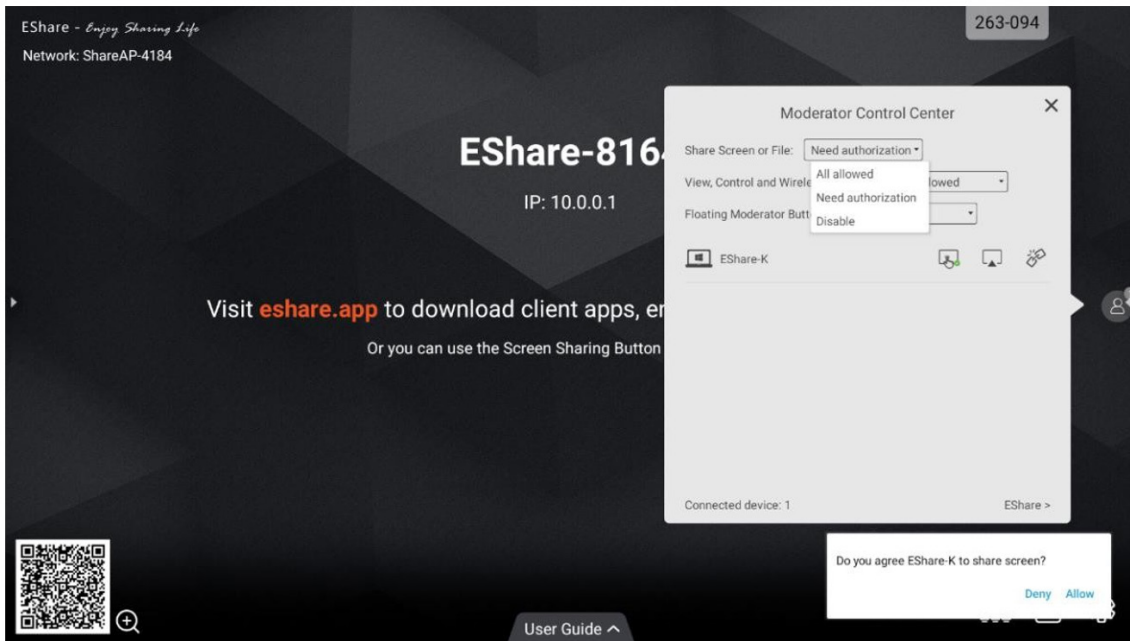

Item	Description
<b>All allowed</b>	Client devices can share their screen or share image/audio/video files to the display. The client application for iOS or Android can also share the camera to the display in real-time.
<b>Need authorization</b>	Client devices can share their screen or share image/audio/videos files or camera to the display only when the option "Allow" is selected in the authorization dialog for screen sharing.
<b>Disable</b>	No client device can share image/audio/video files or camera.

## Options for View, Control, and Wireless Annotation

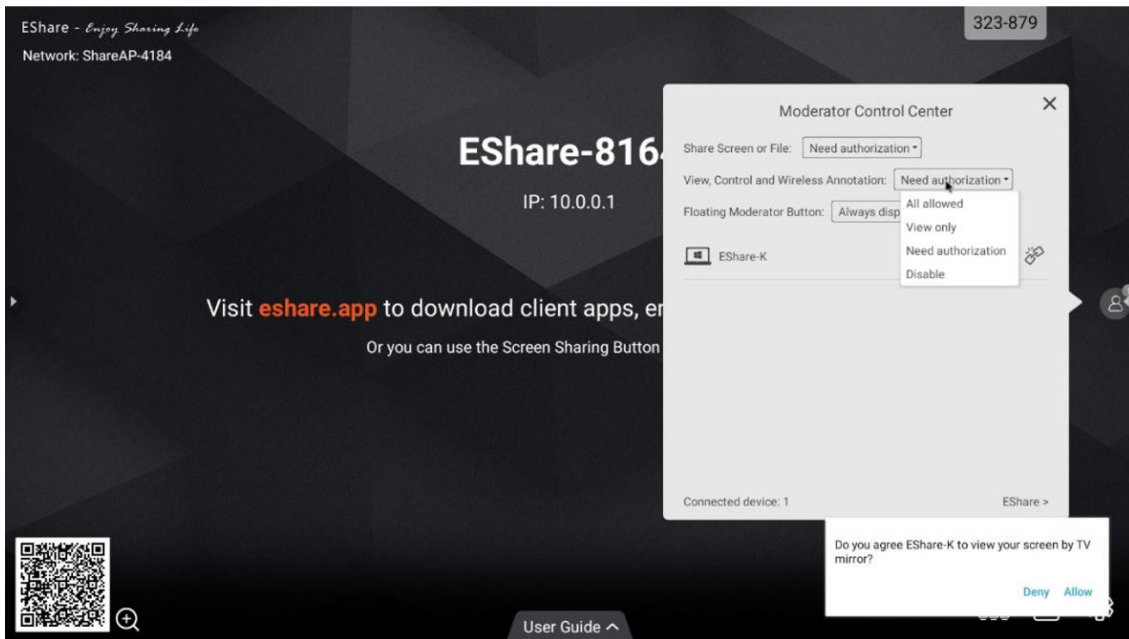

Item	Description
<b>All allowed</b>	Client devices can view and control the display. They can also do annotations in TV Mirror or Remote Control mode.
<b>View Only</b>	Client devices can view the display in TV Mirror but cannot control the display or do annotations.
<b>Need authorization</b>	Client devices can view and control the display. They can also do annotations in TV Mirror or Remote Control mode only when the option “Allow” is selected in the authorization dialog.
<b>Disable</b>	No client device can view or control the display in TV Mirror or Remote Control mode.

## Other Options in the Moderator Control Center

**NOTE:** The client device needs to be connected to the display.

### Invite the Client Device to Share Their Screen

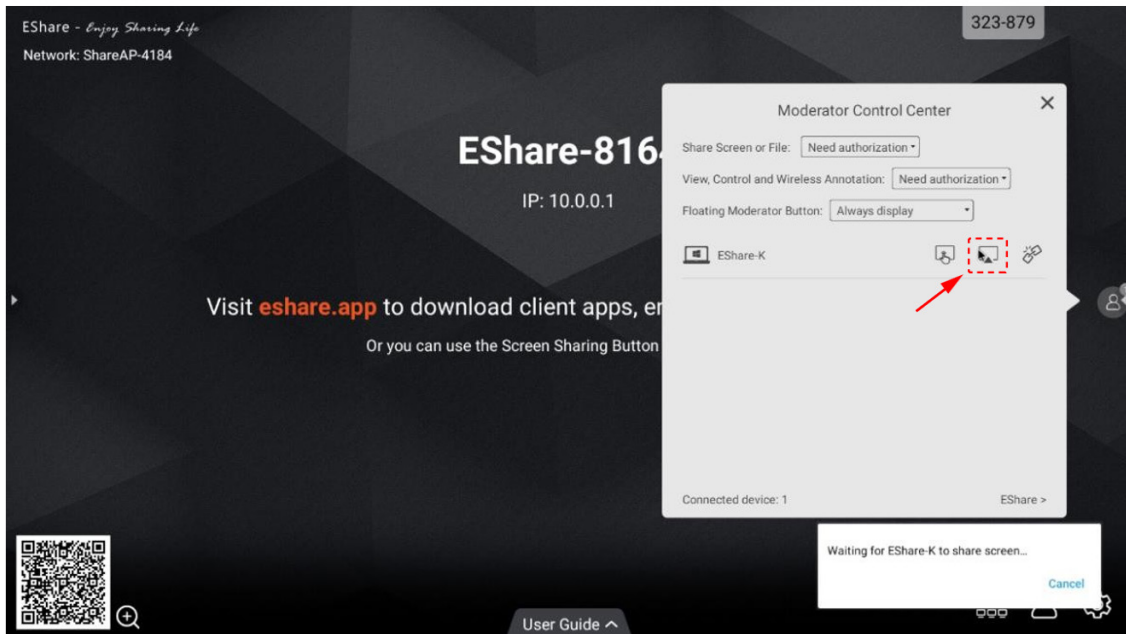

Select any one client device in the Moderator Control Center, and select the button to invite the client device to share their screen. Select this button to stop sharing when the client device is sharing their screen.

### Allow the Client Device to Control the Display

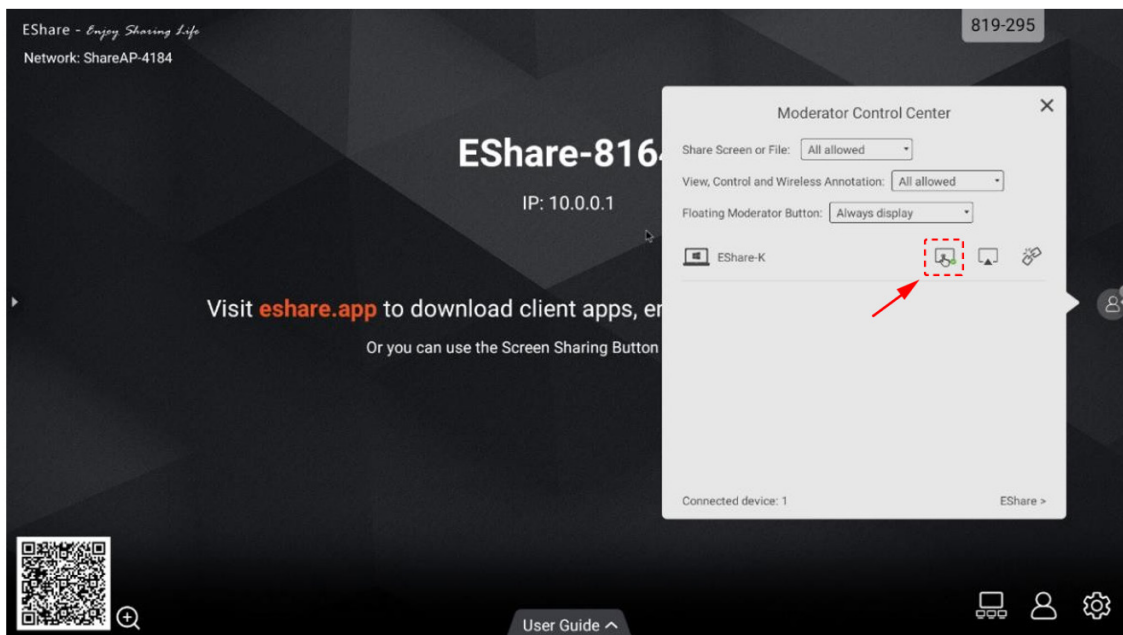

Select the **Screen Control** button to enable or disable the client's control permission for the display. If this button is marked with a small green tick, it means the client can control the display.

## Disconnect the Client Device

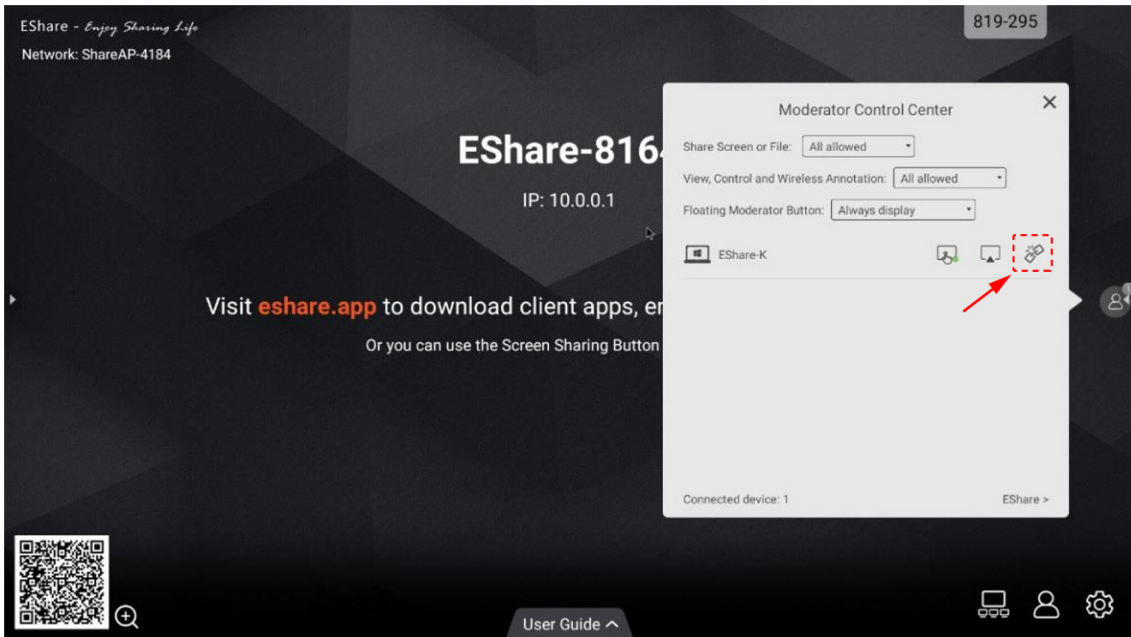

Select the **Disconnect** button and then **OK** in the dialog box to disconnect the client device.

## Casting without EShare

If the AirPlay, Miracast, Chromecast and DLNA applications are preinstalled on the display, you can find the corresponding switches on the EShare Pro settings page to enable them.

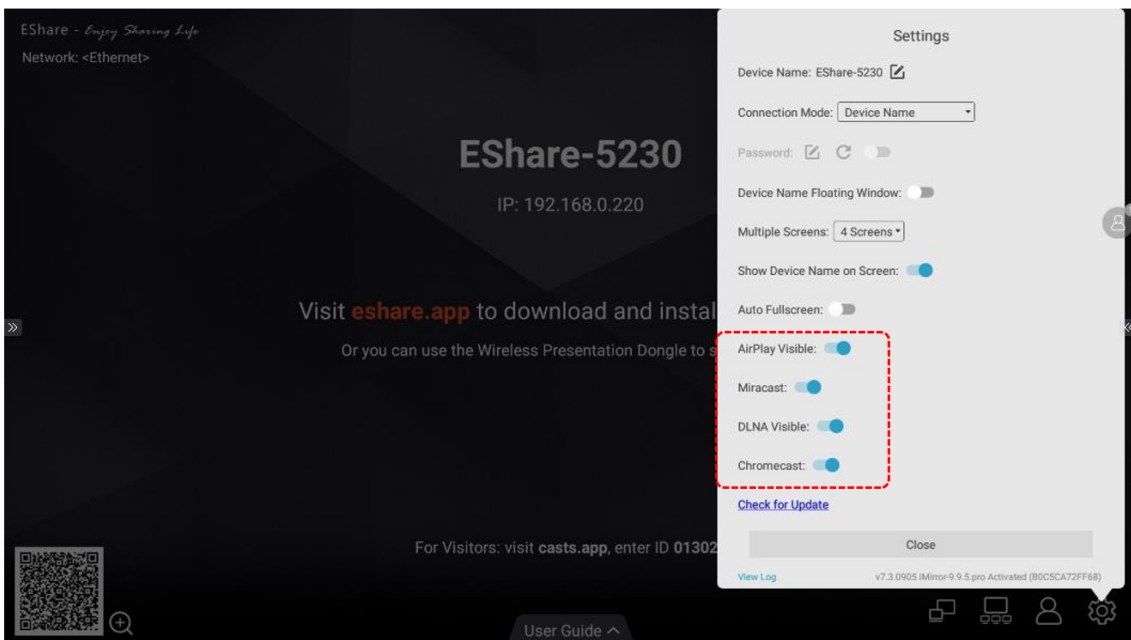

## AirPlay

With AirPlay enabled, Apple devices (e.g., iPhone, iPad, MacBook, iMac) can cast content to the display.

For iPhones:

Directly select Screen Mirroring then select the display to cast to.

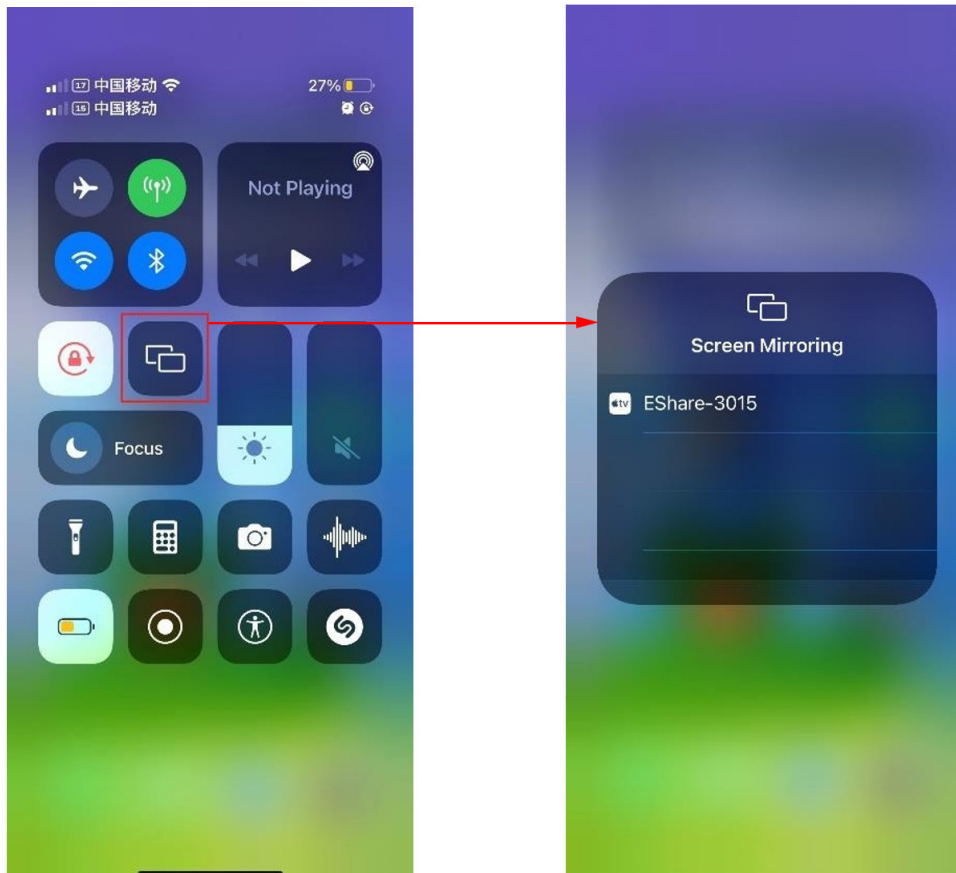

For MacBooks:

Directly select Screen Mirroring then select the display to cast to.



# Miracast

Wirelessly cast content from Windows and Android devices to the display.

**NOTE:** Please make sure the Windows and Android devices are connected to the same network as the display.

## For Windows devices:

1. On the Windows device, press Win + K and select the display to cast to.

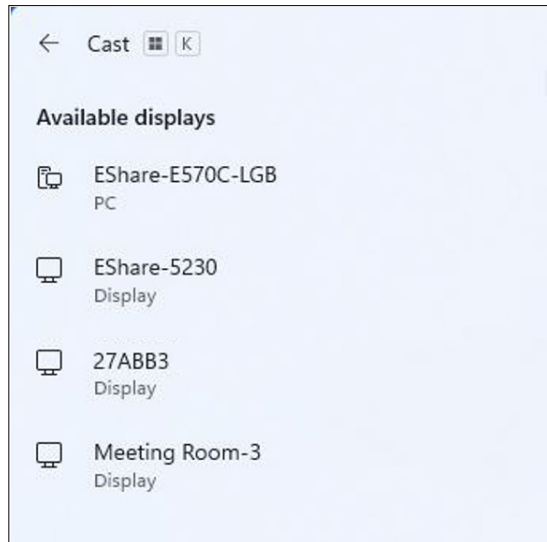

2. Select the checkbox “Allow mouse, keyboard, touch, and pen input from the device” to enable the touch feedback feature.

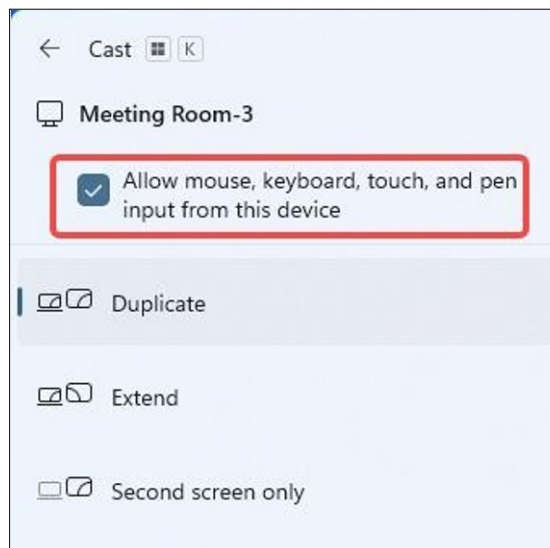

## For Android devices:

On the Android device, directly select Cast/Smart View/Wireless Projection then select the display to cast to.

# Other Default Applications

## Browser

Web browser for surfing the Internet.

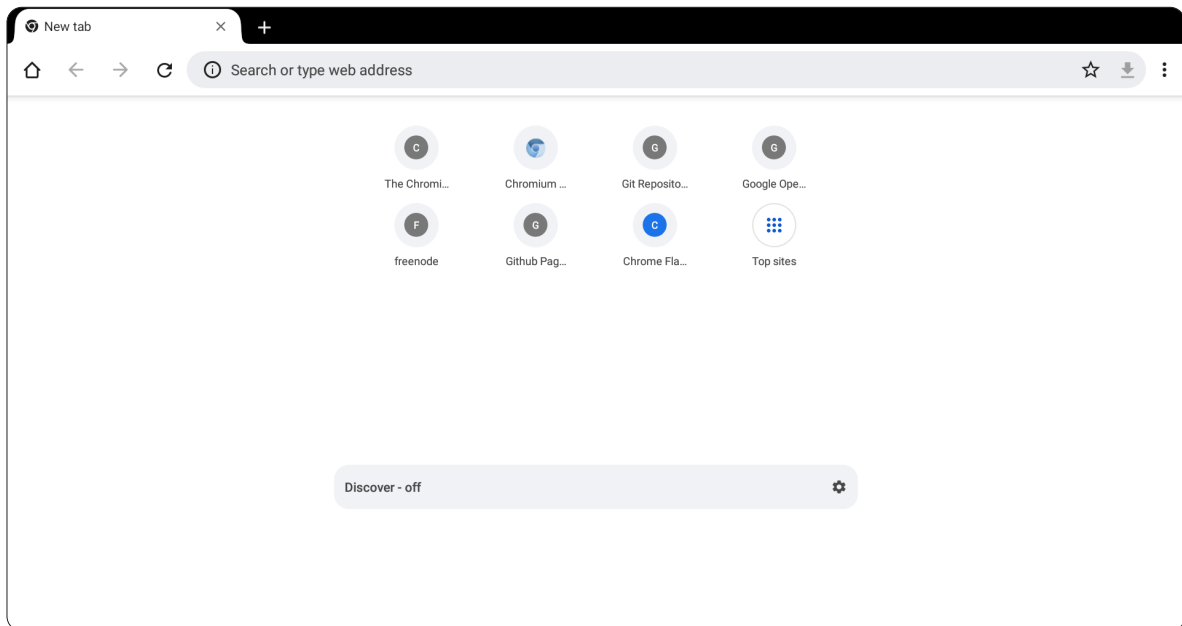

## Easy Upload

Upload mobile phone pictures and text to the display for convenient sharing by scanning the QR code.

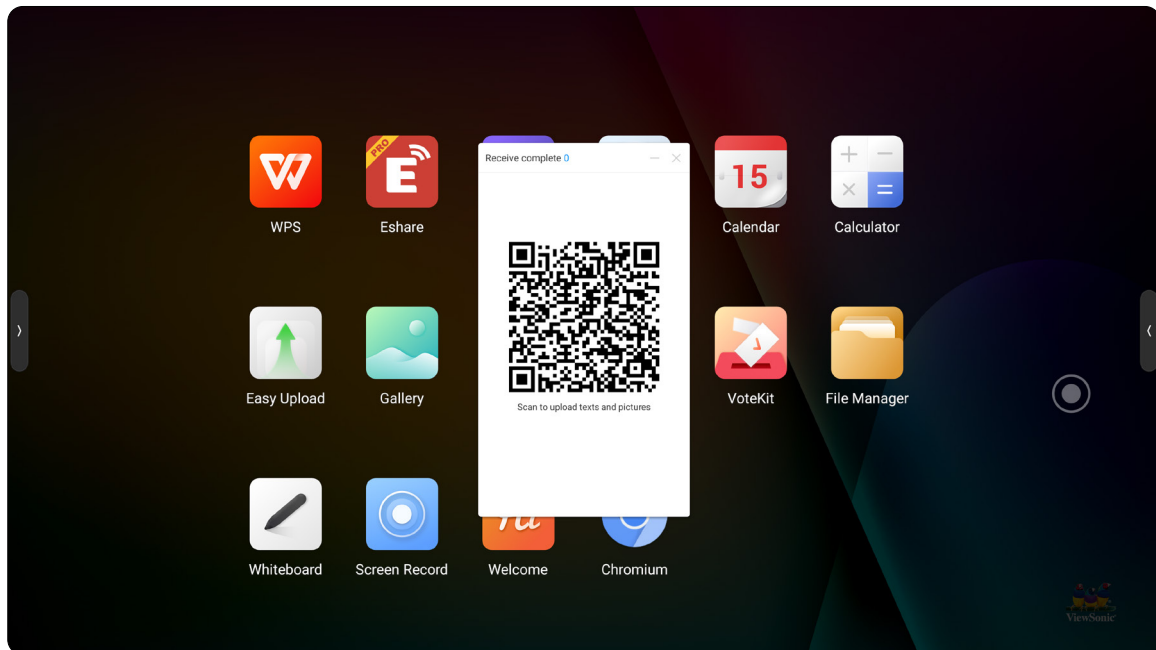

## File Manager

View files on both the local storage of the display and connected external devices.

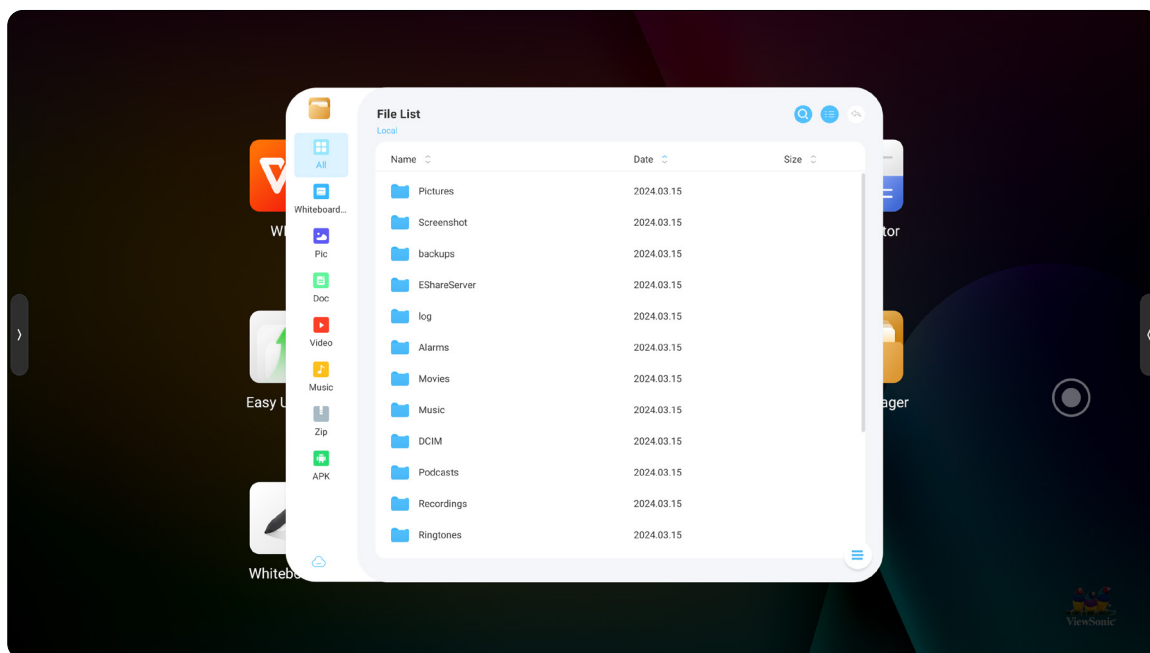

## Gallery

View pictures by swiping left or right on the display.

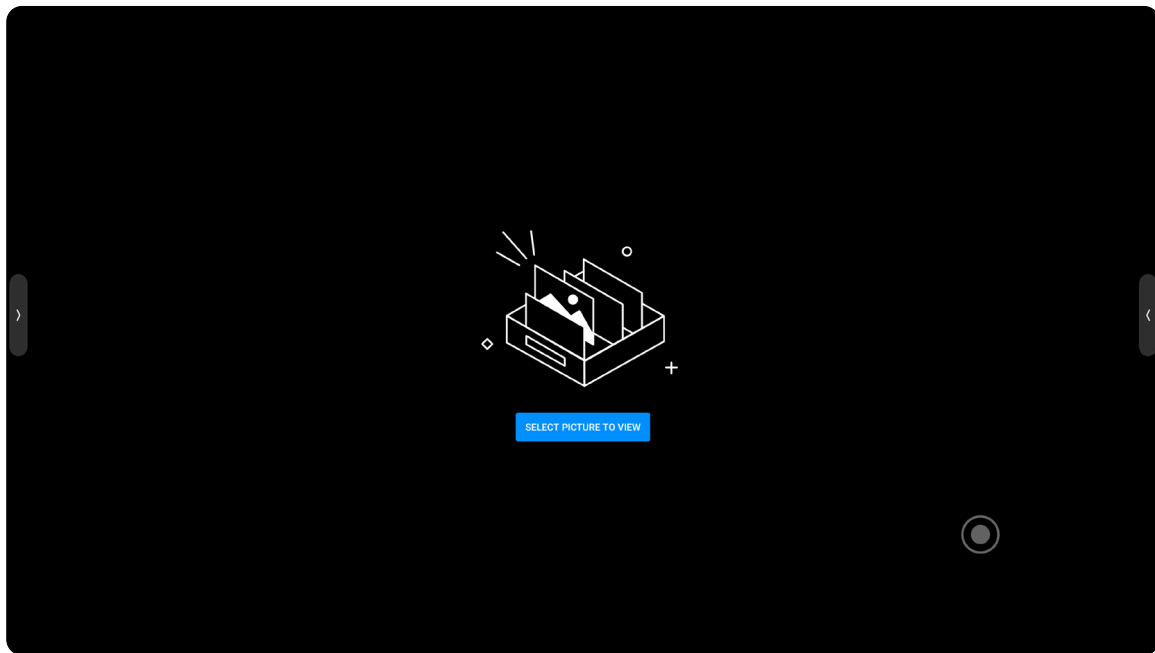

## Hardware Detection

Detect whether the display's hardware is healthy. It can detect local memory, storage, CPU, network status, OPS access, detection module, etc. and can optimize memory, storage space, and CPU usage.

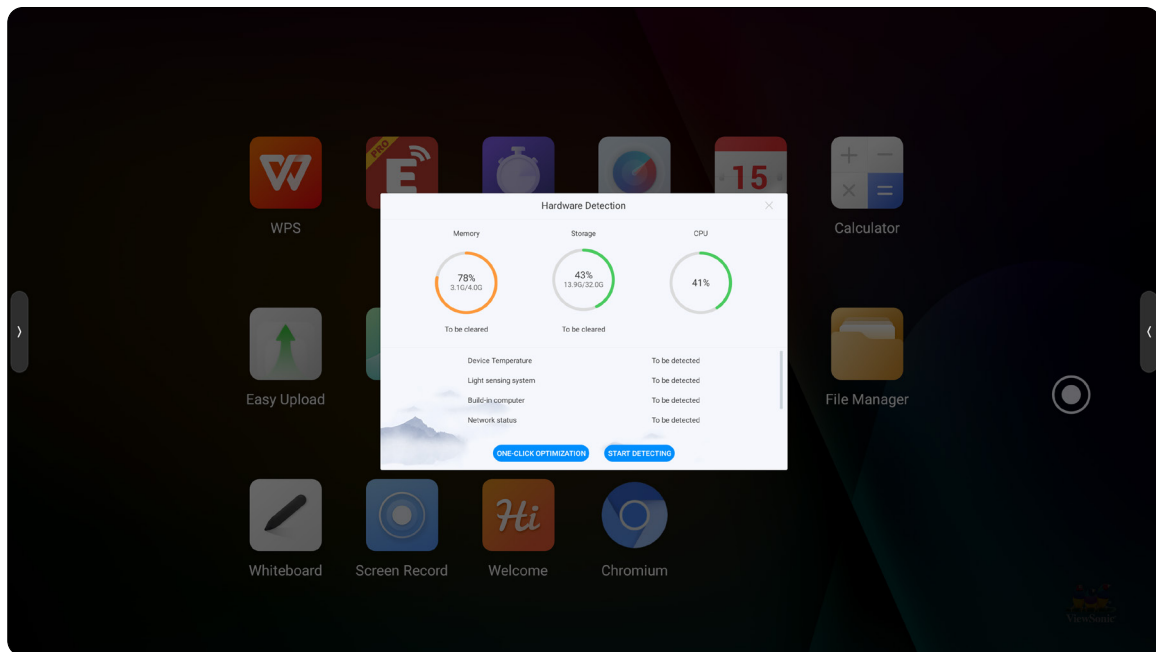

## Screen Record

Record the display's screen, with or without system sound.

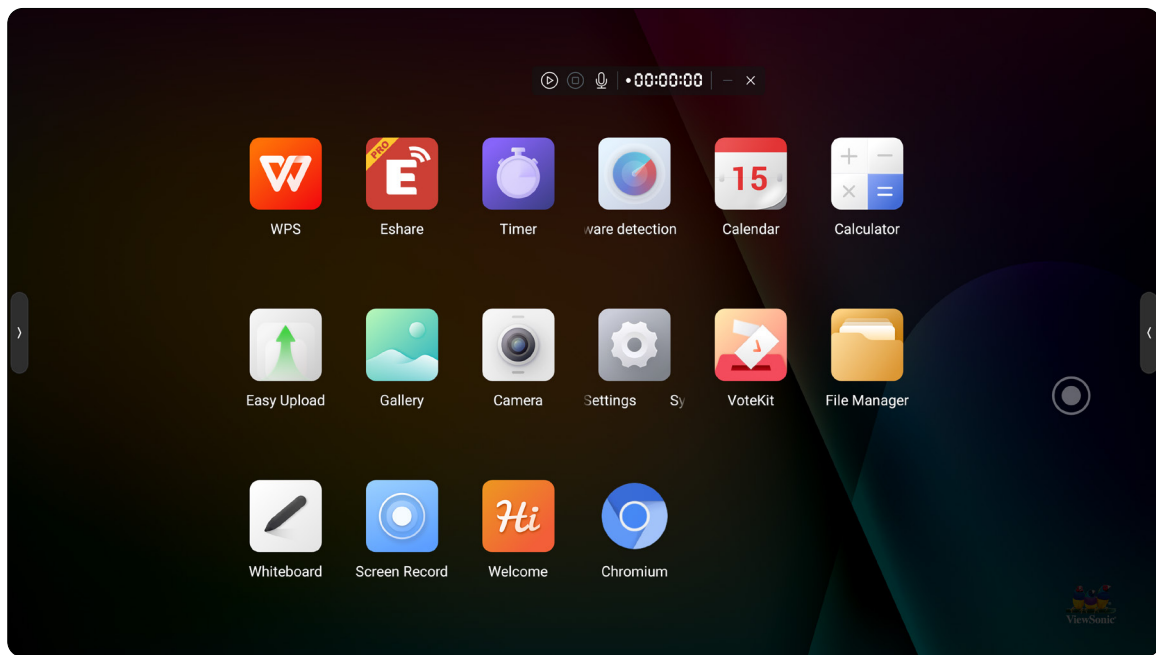

## Screenshot

Capture screen content and save it.

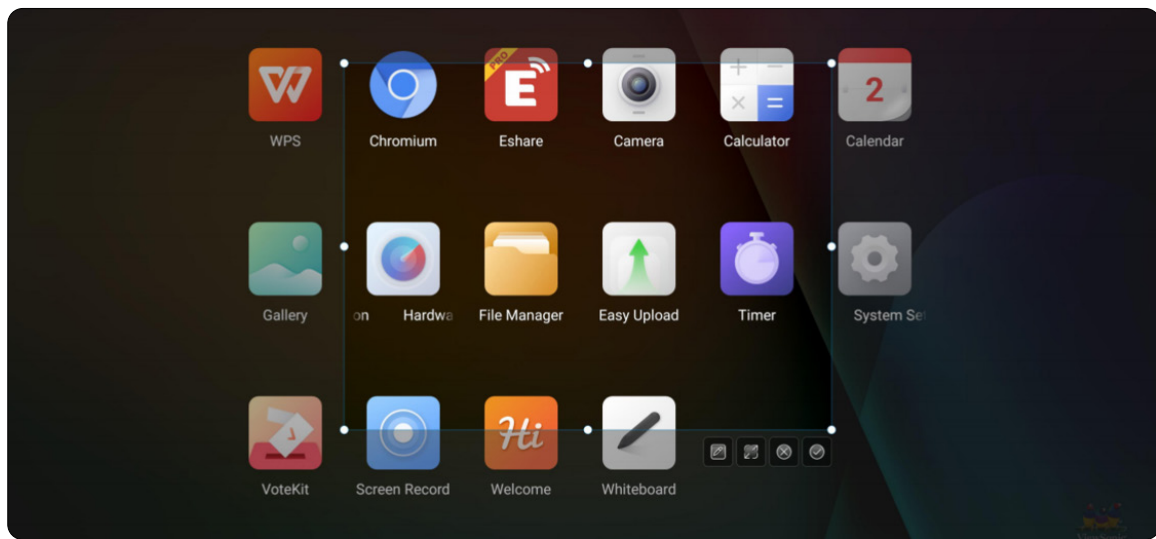



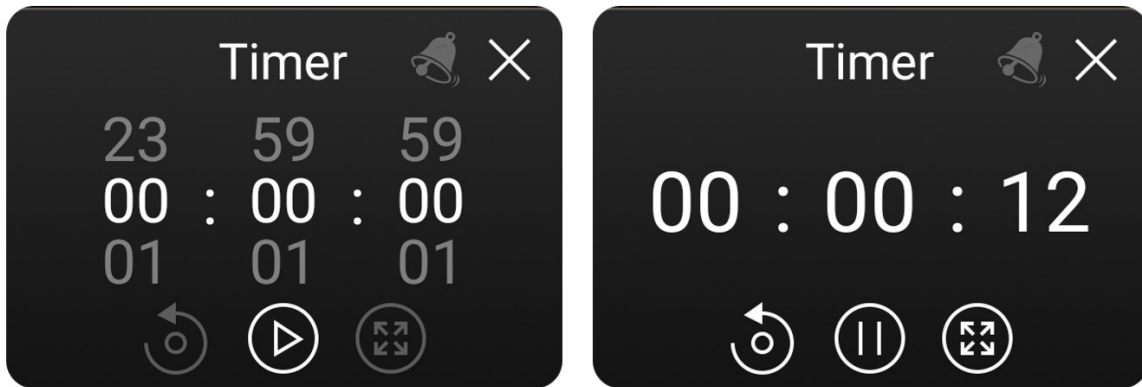

## Timer





The Timer application can be used as both a countdown timer and a stopwatch.



To use as a stopwatch:

1. Open the Timer application by selecting the application icon (.
2. Select the start icon () to start the stopwatch. Select the pause icon () to pause the stopwatch.
3. To reset the time to zero, select the reset icon (). To enter full screen mode select the expand icon (.
4. Select the close icon (X) to exit the application.

To use as a timer:

1. Open the Timer application by selecting the application icon (.
2. Adjust the timer length as needed.
3. Select the start icon () to start the timer. Select the pause icon () to pause the timer.
4. To reset the time to zero, select the reset icon (). To enter full screen mode select the expand icon (.
5. Select the close icon (X) to exit the application.

# VoteKit

Set voting topics.

**NOTE:** VoteKit requires a network connection to be used.

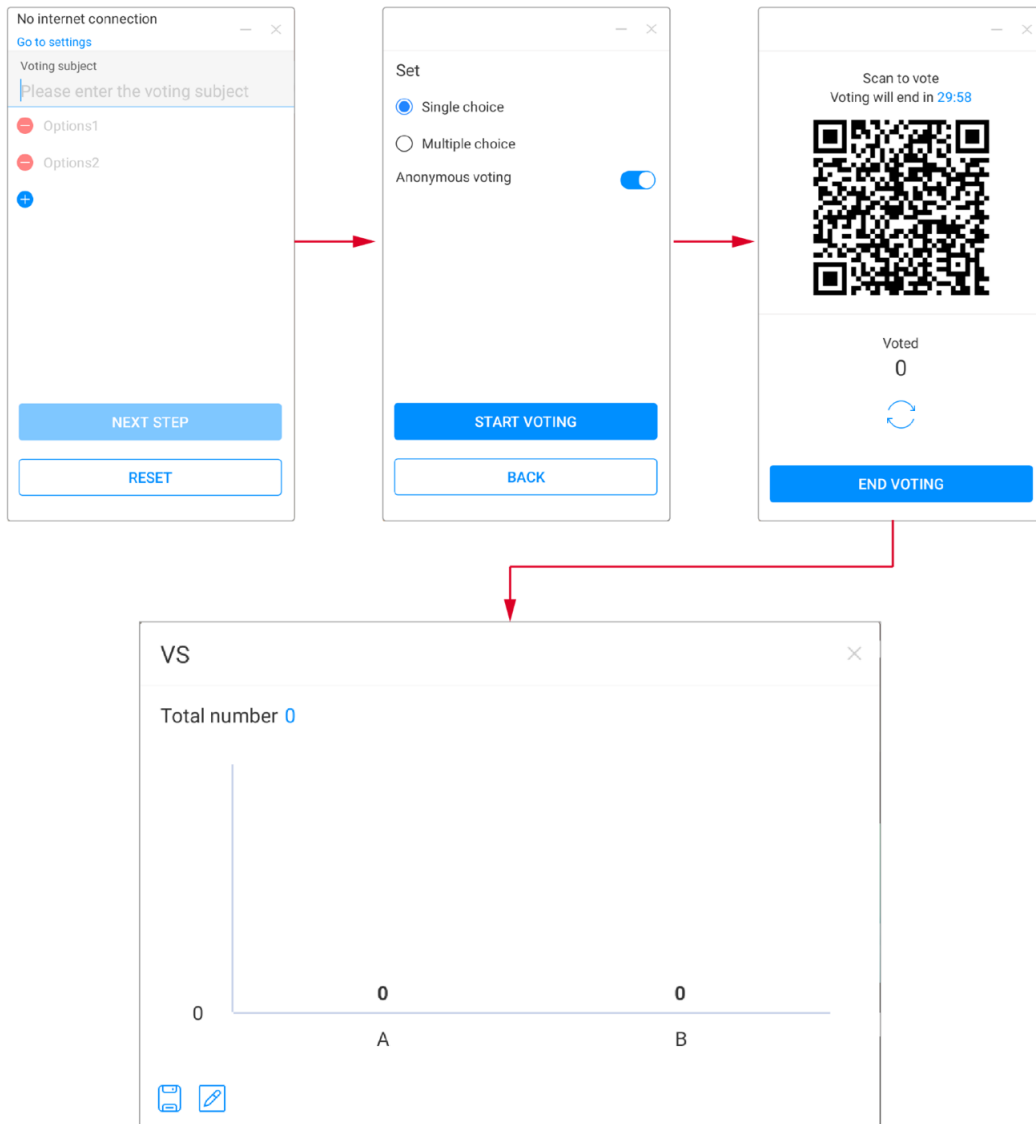

1. Open the VoteKit application by selecting the application icon ()
2. Enter the voting subject and add any necessary options. Select **Next Step**.
3. Set whether the vote will be single or multiple choice. Select **Start Voting**.
4. Participants can scan the QR code to submit their vote.
5. Select **End Voting** to end the vote. The participants' answers will then be displayed. Results can be saved as well.

# Welcome

Choose from templates or create your own welcome screen.

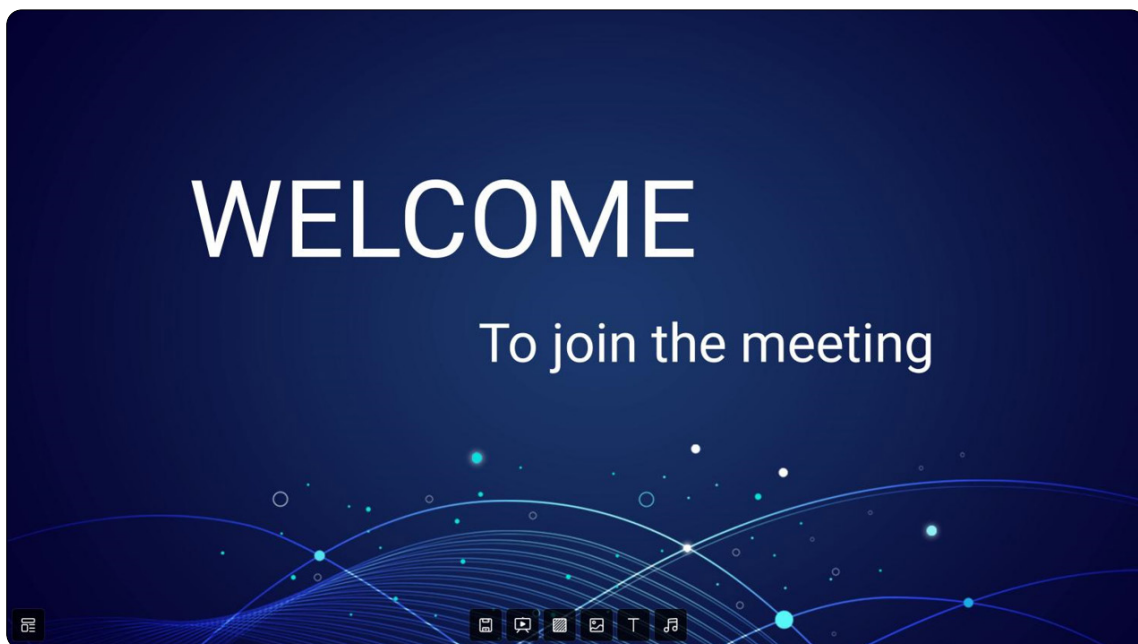
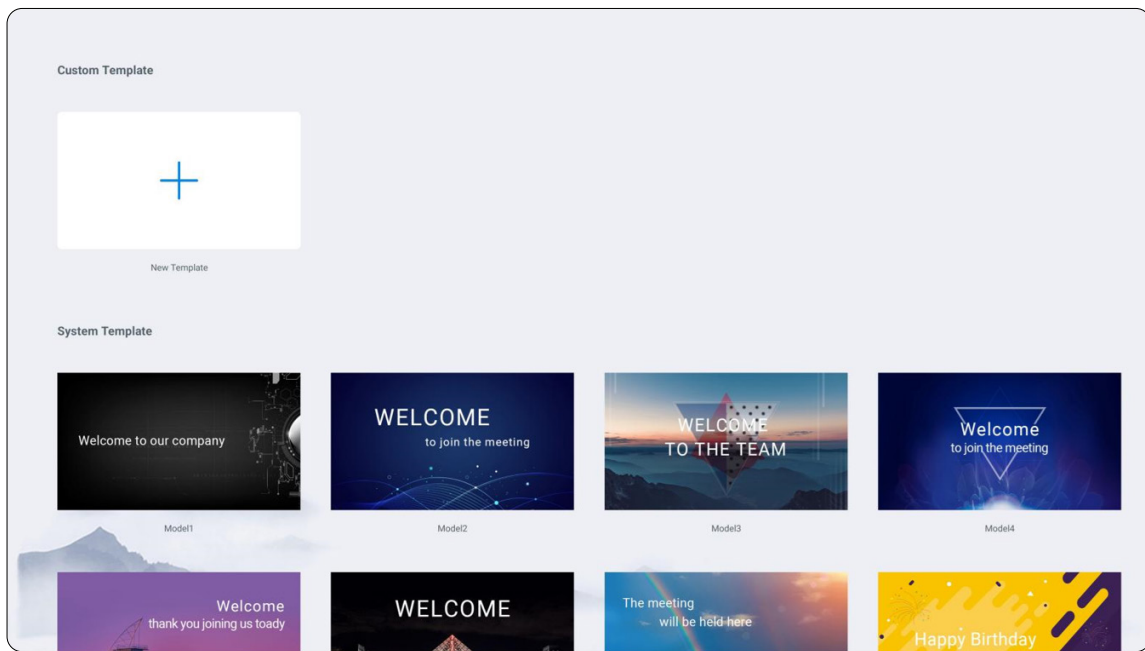



## Whiteboard

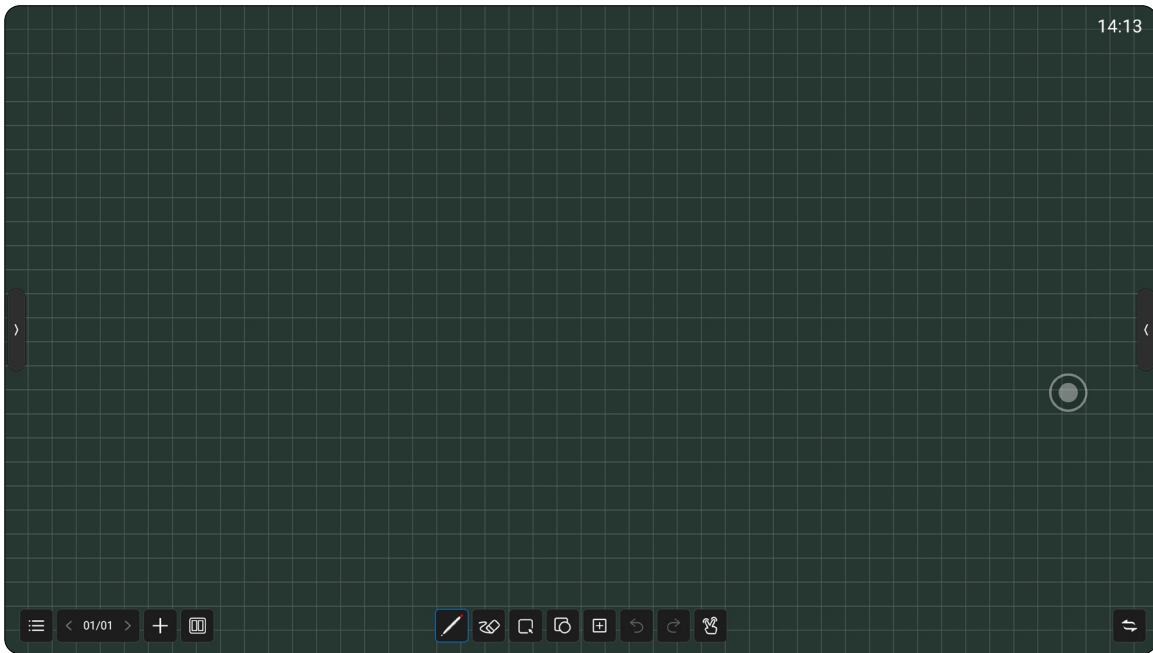



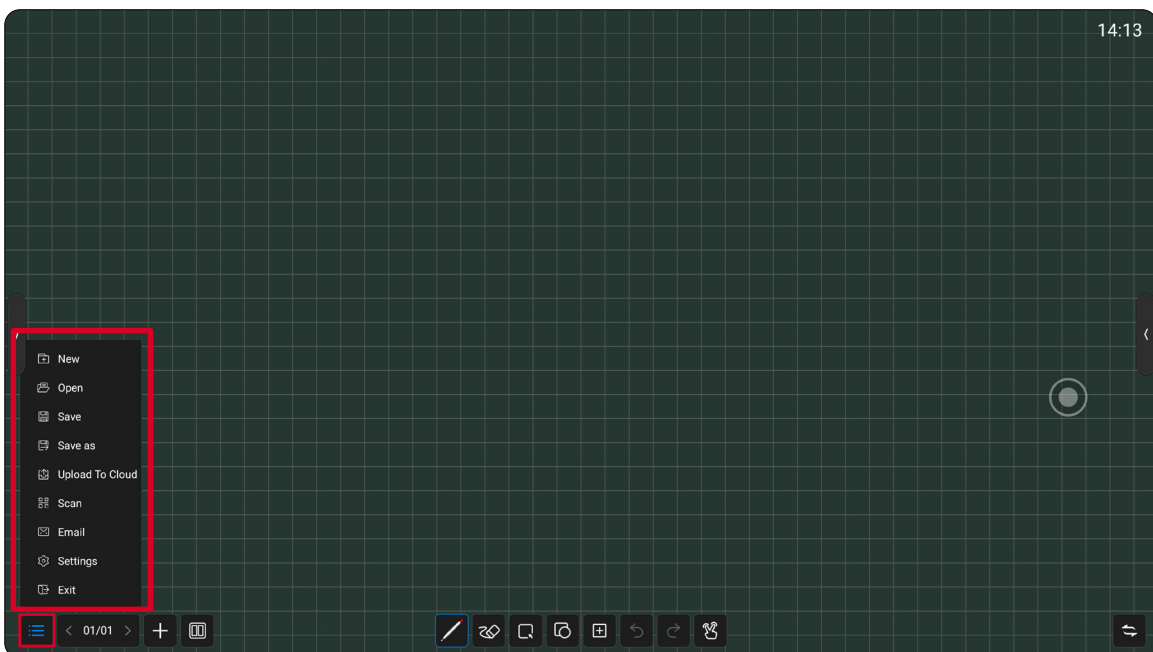

Select the Whiteboard icon (  ) to open the digital whiteboarding application.



## Menu



Item	Description
 <b>New</b>	Create a new whiteboard page.
 <b>Open</b>	Open a file.

Item	Description
 <b>Save</b>	Save the current file.
 <b>Save as</b>	Save another file on the basis of the current file.
 <b>Upload to Cloud</b>	Upload the whiteboard's content to cloud.
 <b>Scan</b>	Share the canvas via QR code. <b>NOTE:</b> Click on the encryption above the QR code to generate a digital password. You will need to enter the password to get the content after scanning the code.
 <b>Email</b>	Share the current whiteboard content by email.
 <b>Settings</b>	Set the basic settings of the whiteboard.
 <b>Exit</b>	Close the whiteboard.

# Settings

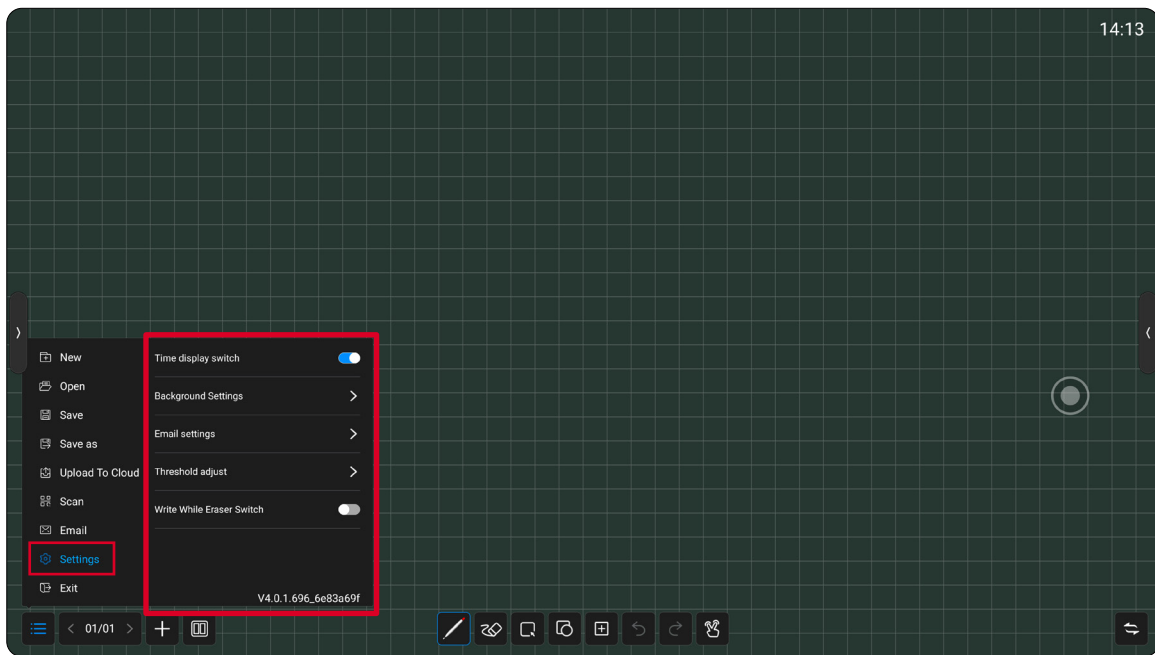

Item	Description
<b>Time Display Switch</b>	Choose to display the time on the whiteboard.
<b>Background Settings</b>	Set the background color and grid style.
<b>Email Settings</b>	Set the sender's email address for sharing the whiteboard canvas by email.
<b>Threshold Adjust</b>	Adjust the line thickness when writing and the size of the eraser.
<b>Write While Erase Switch</b>	Hide the bottom toolbar.

## Page Mangement

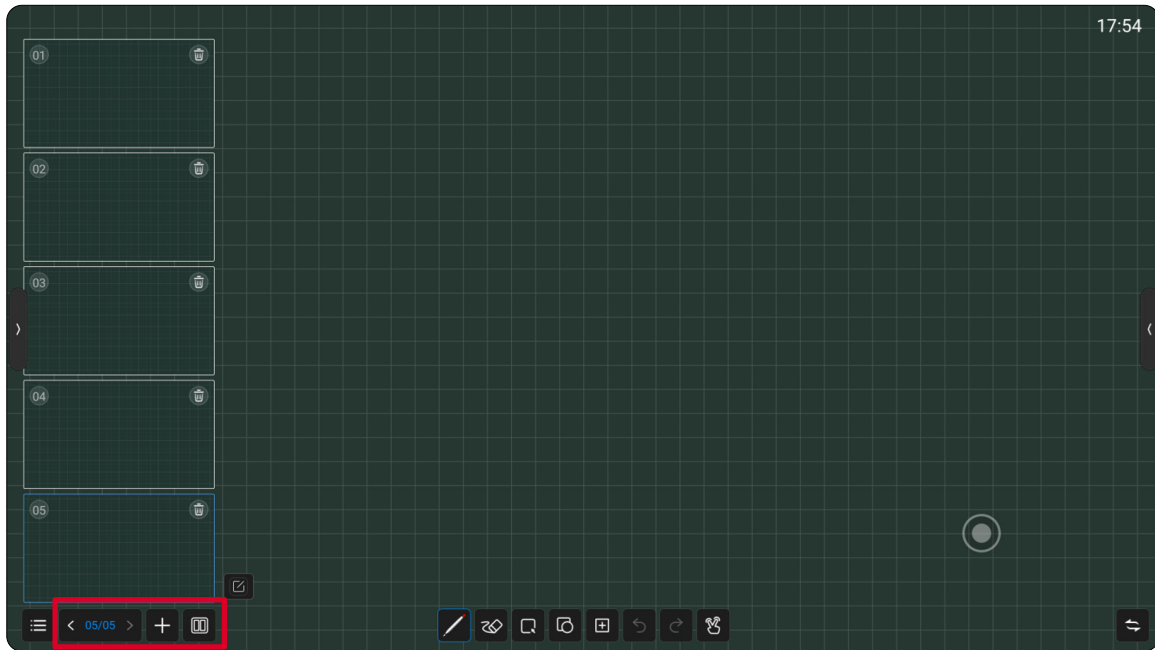

Item	Description
<b>Previous Page</b>	Go to the previous page (if the canvas has multiple pages).
<b>Page Number</b>	Indicates the page number.
<b>Next Page</b>	Go to the next page (if the canvas has multiple pages).
<b>Add Page</b>	Add a new canvas.
<b>Partition</b>	Divide the whiteboard area into up to 4 zones for simultaneous writing.

## Bottom Toolbar

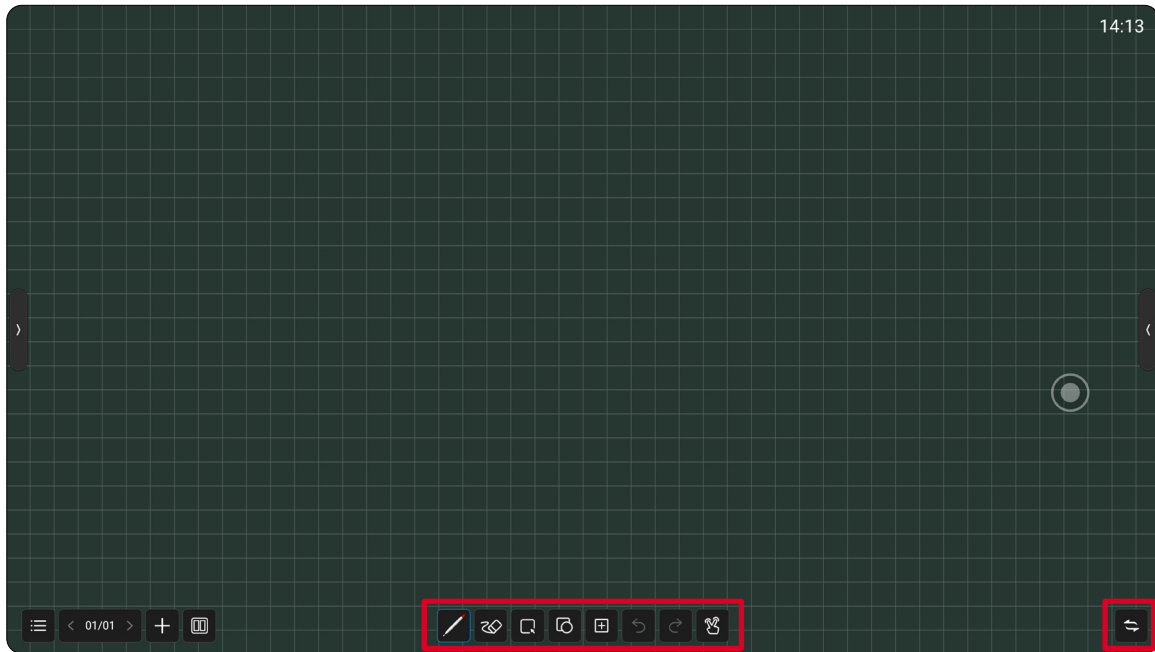

Item	Description
<b>Paint Brush</b>	Writing tools with customization options.
<b>Eraser</b>	Select to erase canvas content.
<b>Select</b>	Select elements on the canvas.
<b>Graphics</b>	Draw various types of graphics on the canvas.
<b>Insert</b>	Insert images, forms, mind maps, and other elements onto the canvas.
<b>Undo</b>	Undo the last action.
<b>Redo</b>	Redo the previously undone action.
<b>Single Point/ Multi-Point</b>	Choose between single point and multiple point (up to 20 points) input.
<b>Switch</b>	Change the toolbar's position on screen.

## Mini Whiteboard

On any page, swipe up from the bottom of the display to quickly bring up the mini whiteboard.

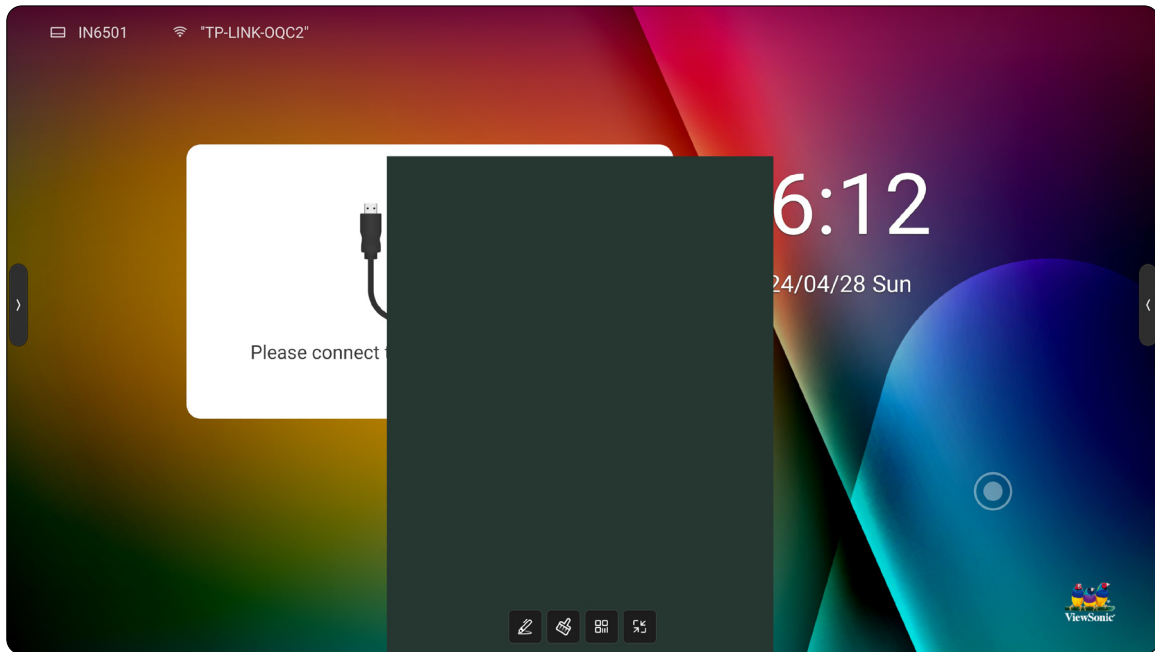

Item	Description
<b>Paint Brush</b>	Writing tools with customization options.
<b>Eraser</b>	Select to erase canvas content.
<b>QR Code</b>	Share the canvas via QR code. <b>NOTE:</b> Click on the encryption above the QR code to generate a digital password. You will need to enter the password to get the content after scanning the code.
<b>Minimize</b>	Collapse the mini whiteboard.

# RS-232 Protocol

This document describes the hardware interface and software protocols of RS-232 interface communication between the ViewSonic LED Display and computers or other control units with RS-232 protocol.

The protocol contains three command sections:

- Set-Function
- Get-Function
- Remote control pass-through mode

**NOTE:** Below, “PC” represents all the control units that can send or receive the RS-232 protocol command.

## Description

### RS-232 Hardware Specification

ViewSonic LFD communication port on the rear side:

1. Connector type: DSUB 9-Pin Male (female or 3.5 mm barrel connector)
2. Use of crossover (null modem) cable for connection
3. Pin Assignment:

Male DSUB 9-Pin  
(preferred)

1 2 3 4 5



6 7 8 9

Female DSUB 9-Pin

5 4 3 2 1



9 8 7 6

3.5 mm barrel connector  
(alternative for limited  
space)



Pin #	Signal	Remark
1	NC	
2	RXD	Input to Display
3	TXD	Output from Display
4	NC	
5	GND	
6	NC	
7	NC	
8	NC	
9	NC	
frame	GND	

Item	Signal	Remark
Tip	TXD	Output from Display
Ring	RXD	Input to Display
Sleeve	GND	

## LAN Hardware Specification

ViewSonic LFD communication port on the rear side:

1. Connector type: 8P8C RJ45
2. Pin Assignment:

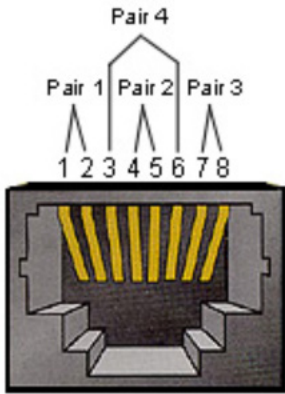

Pin #	Signal	Remark
1	TX+	Output from Display
2	TX-	Output from Display
3	RX+	Input to Display
4	BI_D3+	For 1G case
5	BI_D3-	For 1G case
6	RX-	Input to Display
7	BI_D4+	For 1G case
8	BI_D4-	For 1G case
frame	GND	

## RS-232 Communication Setting

- Baud Rate Select: 115200 bps (fixed)
- Data bits: 8 bits (fixed)
- Parity: None (fixed)
- Stop Bits: 1 (fixed)

## LAN Communication Setting

Type: Ethernet  
 Protocol: TCP/IP  
 Port: 5000 (fixed)  
 WOL Port: 9 (fixed) for UDP\*3.2.0  
 Cross subnet: No  
 Logon Credentials: No

## Command Message Reference

PC sends to LFD command packet followed by “CR”. Every time PC sends control command to Display, the Display shall respond as follows:

1. If the message is received correctly it will send “+” (02Bh) followed by “CR” (00Dh)
2. If the message is received incorrectly it will send “-” (02Dh) followed by “CR” (00Dh)

# Protocol

## Set-Function Listing

The PC can control the Display for specific actions. The Set-Function command allows you to control the Display behavior at a remote site through the RS-232 port. The Set-Function packet format consists of 9 bytes.

Item	Description	
<b>Communication Configuration</b>	Communication interface	RS-232
	Communication protocol	Uart
	Baud rate	115200
	Data bits	8
	Stop bits	1
	Parity check	None
<b>Packet Description</b>	Packet byte encoding	Hexadecimal
	Is there a maximum limit on the package length	No
	Whether there is package verification	No

## Set-Function Table (Basic Function)

### Whole Machine Management

Description	Command Code	Response Code	Note	Return Code Description
Power On	FE 08 58 42 48 43 4D 44 01 F0 CF	FE 09 58 42 48 43 4D 44 01 F0 01 CF	Wake up serial port during standby	
Power off	FE 08 58 42 48 43 4D 44 01 F1 CF	FE 09 58 42 48 43 4D 44 01 F1 01 CF		
Hibernate	FE 08 58 42 48 43 4D 44 01 F2 CF	FE 09 58 42 48 43 4D 44 01 F2 01 CF	Turn off display and sound	
Exit Hibernation	FE 08 58 42 48 43 4D 44 10 F3 CF	FE 09 58 42 48 43 4D 44 01 F3 01 CF	Turn on display and sound	
Get Device Status	FE 08 58 42 48 43 4D 44 02 08 CF	FE 09 58 42 48 43 4D 44 02 08 XX CF		xx (Device Status): 00: Standby 01: Power on 02: Hibernate
Restart the System	FE 08 58 42 48 43 4D 44 01 43 CF	FE 09 58 42 48 43 4D 44 01 43 01 CF		
Android	FE 08 58 42 48 43 4D 44 01 44 CF	FE 09 58 42 48 43 4D 44 01 44 01 CF		
Get Android Version	FE 08 58 42 48 43 4D 44 02 21 CF	FE LL 58 42 48 43 4D 44 02 21 X1 X2 ...Xn CF		LL: Data length, excluding header, footer and itself.  Get Android version number: X1...Xn indicates the Android version number (ASCII code), including the compilation time (equivalent to the version information in the system settings), such as: V3.1.4_20180907.70824_8ff73a3

Description	Command Code	Response Code	Note	Return Code Description
Get the Mainboard Software Model Name	FE 08 58 42 48 43 4D 44 02 27 CF	FE LL 58 42 48 43 4D 44 02 27 X1 X2 ...Xn CF	Turn off display and sound	LL: Data length, excluding header, footer and itself. Get the software model name information: X1...Xn Indicates model name information (ASCII code)
Get Machine SN	FE 08 58 42 48 43 4D 44 02 28 CF	FE LL 58 42 48 43 4D 44 02 28 X1 X2 ...Xn CF		LL: Data length, excluding header, footer and itself. Get machine serial number information: X1...Xn Indicates serial number information (ASCII code)
Get Machine Temperature	FE 08 58 42 48 43 4D 44 02 33 CF	FE 09 58 42 48 43 4D 44 02 33 XX CF		XX: Temperature (DEG C)
Set Language	FE 09 58 42 48 43 4D 44 03 0F XX CF	FE 0A 58 42 48 43 4D 44 03 0F XX YY CF		XX: 0x00: 简体中文 0x01: English 0x02: 繁體中文 YY: Set judgement 0x00: Fail 0x01: Success
Get Language	FE 08 58 42 48 43 4D 44 02 0F CF	FE 09 58 42 48 43 4D 44 02 0F XX CF		XX: 0x00: 简体中文 0x01: English 0x02: 繁體中文

Description	Command Code	Response Code	Note	Return Code Description
Get Current Channel	FE 08 58 42 48 43 4D 44 02 39 CF	FE 09 58 42 48 43 4D 44 02 39 XX CF		XX: Channel number FF: Undefined channel 05: VGA 09: HDMI1 0A: HDMI2 0F: F_HDMI1 13: OPS1 14: OPS2 15: Android  YY: 00: Fail 01: Success

## Source Management

Description	Command Code	Response Code	Note	Return Code Description
Signal Source	FE 08 58 42 48 43 4D 44 01 11 CF	FE 09 58 42 48 43 4D 44 01 11 01 CF		
HD1 (HDMI1)	FE 08 58 42 48 43 4D 44 01 03 CF	FE 09 58 42 48 43 4D 44 01 03 01 CF		
HD2 (HDMI2)	FE 08 58 42 48 43 4D 44 01 04 CF	FE 09 58 42 48 43 4D 44 01 04 01 CF		
OPS Computer (HDMI6)	FE 08 58 42 48 43 4D 44 01 08 CF	FE 09 58 42 48 43 4D 44 01 08 01 CF		
VGA	FE 08 58 42 48 43 4D 44 01 0A CF	FE 09 58 42 48 43 4D 44 01 0A 01 CF		
Front HDMI	FE 08 58 42 48 43 4D 44 05 02 CF	FE 09 58 42 48 43 4D 44 05 02 01 CF		
Set the Default Channel for Power On	FE 09 58 42 48 43 4D 44 03 0B XX CF	FE 0A 58 42 48 43 4D 44 03 0B XX YY CF		XX: Channel number  FF: Undefined channel 05: VGA 09: HDMI1 0A: HDMI2 0F: F_HDMI1 13: OPS1 14: OPS2 15: Android  YY: 00: Fail 01: Success

## Sound Management

Description	Command Code	Response Code	Note	Return Code Description
Set Mute/ Unmute	FE 09 58 42 48 43 4D 44 03 12 XX CF	FE 0A 58 42 48 43 4D 44 03 12 XX YY CF		XX: 00: Mute 01: Unmute  YY: 00: Fail 01: Success
Get Mute Status	FE 08 58 42 48 43 4D 44 02 12 CF	FE 09 58 42 48 43 4D 44 02 12 XX CF		XX: 00: Mute 01: Unmute
Mute	FE 08 58 42 48 43 4D 44 01 14 CF	FE 09 58 42 48 43 4D 44 01 14 01 CF		When it is not muted, it will be switched to muted; When it is currently muted, it will be switched to unmuted.
Set Volume	FE 09 58 42 48 43 4D 44 03 03 XX CF	FE 0A 58 42 48 43 4D 44 03 03 XX YY CF		XX: Indicates the volume value (0~100), corresponding to hexadecimal: 00~64  YY: 00: Fail 01: Success
Get Volume	FE 08 58 42 48 43 4D 44 02 03 CF	FE 09 58 42 48 43 4D 44 02 03 XX CF		XX: Indicates the volume value (0~100), corresponding to hexadecimal: 00~64
Sound -	FE 08 58 42 48 43 4D 44 01 18 CF	FE 09 58 42 48 43 4D 44 01 18 XX CF	When the volume is decreased by 1 unit and is currently 100, return failure.	
Sound +	FE 08 58 42 48 43 4D 44 01 19 CF	FE 09 58 42 48 43 4D 44 01 19 XX CF	When the volume is increased by 1 unit and is currently 100, return failure.	XX: 00: Fail 01: Success

Description	Command Code	Response Code	Note	Return Code Description
Set Image Mode	FE 09 58 42 48 43 4D 44 03 02 XX CF	FE 0A 58 42 48 43 4D 44 03 02 XX YY CF	The video signal source is valid	XX indicates image mode: 0x00: Standard 0x01: Dynamic 0x02: User defined 0x03: Bright 0x04: Bright YY: 00: Fail 01: Success
Get Image Mode	FE 08 58 42 48 43 4D 44 02 02 CF	FE 09 58 42 48 43 4D 44 02 02 XX CF		XX indicates image mode: 0x00: Standard 0x01: Dynamic 0x02: User defined 0x03: Bright 0x04: Bright
Set Image Contrast	FE 09 58 42 48 43 4D 44 03 21 XX CF	FE 0A 58 42 48 43 4D 44 03 21 XX YY CF		XX: 0x00~0x64 YY: 00: Fail 01: Success
Get Image Contrast	FE 08 58 42 48 43 4D 44 02 34 CF	FE 09 58 42 48 43 4D 44 02 34 XX CF		XX: 0x00~0x64
Set Image Brightness	FE 09 58 42 48 43 4D 44 03 22 XX CF	FE 0A58 42 48 43 4D 44 03 22 XX YY CF		YY: 00: Fail 01: Success
Get Image Brightness	FE 08 58 42 48 43 4D 44 02 35 CF	FE 09 58 42 48 43 4D 44 02 35 XX CF		XX: 0x00~0x64
Set Image Saturation	FE 09 58 42 48 43 4D 44 03 24 XX CF	FE 0A58 42 48 43 4D 44 03 24 XX YY CF		XX: 0x00~0x64
Get Image Saturation	FE 08 58 42 48 43 4D 44 02 40 CF	FE 09 58 42 48 43 4D 44 02 40 XX CF		
Set Image Sharpness	FE 09 58 42 48 43 4D 44 03 25 XX CF	FE 0A58 42 48 43 4D 44 03 25 XX YY CF		XX: 0x00~0x64
Get Image Sharpness	FE 08 58 42 48 43 4D 44 02 41 CF	FE 09 58 42 48 43 4D 44 02 41 XX CF		XX: 0x00~0x64 YY: 00: Fail 01: Success

## Backlight Management

Description	Command Code	Response Code	Note	Return Code Description
Set Backlight Brightness	FE 09 58 42 48 43 4D 44 03 04 XX CF	FE 0A 58 42 48 43 4D 44 03 04 XX YY CF		XX: Indicates the brightness value (0~100), corresponding to hexadecimal: 00~64  YY: 00: Fail 01: Success
Get Backlight Brightness	FE 08 58 42 48 43 4D 44 02 04 CF	FE 09 58 42 48 43 4D 44 02 04 XX CF		XX: Indicates the brightness value (0~100), corresponding to hexadecimal: 00~64
Set Backlight Mode	FE 09 58 42 48 43 4D 44 03 05 XX CF	FE 0A 58 42 48 43 4D 44 03 05 XX YY CF		XX: 00: Standard 01: Energy Saving 02: Automatic 03: Custom  YY: 00: Fail 01: Success
Get Backlight Mode	FE 08 58 42 48 43 4D 44 02 05 CF	FE 09 58 42 48 43 4D 44 02 05 XX CF		XX: 00: Standard 01: Energy Saving 02: Automatic 03: Custom
Get Backlight Switch Status	FE 08 58 42 48 43 4D 44 02 0A CF	FE 09 58 42 48 43 4D 44 02 0A XX CF		XX: 00: Off 01: On
Set Backlight Switch Status	FE 09 58 42 48 43 4D 44 03 0A XX CF	FE 0A 58 42 48 43 4D 44 03 0A XX YY CF		XX: 00: Off 01: On  YY: 00: Fail 01: Success

## Authority Management

Description	Command Code	Response Code	Note	Return Code Description
Turn On Child Lock Mode	FE 09 58 42 48 43 4D 44 03 07 01 CF	FE 0A 58 42 48 43 4D 44 03 07 01 XX CF		XX: 00: Fail 01: Success
Turn Off Child Lock Mode	FE 09 58 42 48 43 4D 44 03 07 00 CF	FE 0A 58 42 48 43 4D 44 03 07 00 XX CF		XX: 00: Fail 01: Success
Get Child Lock Mode Status	FE 08 58 42 48 43 4D 44 02 07 CF	FE 09 58 42 48 43 4D 44 02 07 XX CF		XX indicates child lock status: 00: Child lock closed 01: Child lock open
Set the Keyboard Disable/ Enable	FE 09 58 42 48 43 4D 44 03 10 XX CF	FE 0A 58 42 48 43 4D 44 03 10 XX YY CF		XX: 0x00: Disable 0x01: Enable YY: 00: Fail 01: Success
Get the Disable/ Enable Status of Remote Control Keys	FE 08 58 42 48 43 4D 44 02 11 CF	FE 09 58 42 48 43 4D 44 02 11 XX CF		XX: 0x00: Disable 0x01: Enable

## Function Shortcuts Key

Description	Command Code	Response Code	Note	Return Code Description
Listen Alone - On	FE 08 58 42 48 43 4D 44 01 17 CF	FE 09 58 42 48 43 4D 44 01 17 01 CF		
Listen Alone - Off	FE 08 58 42 48 43 4D 44 01 12 CF	FE 09 58 42 48 43 4D 44 01 12 01 CF		
Display	FE 08 58 42 48 43 4D 44 01 12 CF	FE 09 58 42 48 43 4D 44 01 12 01 CF		Effective under signal source.
Screenshot	FE 08 58 42 48 43 4D 44 01 1E CF	FE 09 58 42 48 43 4D 44 01 1E 01 CF		
Zoom	FE 08 58 42 48 43 4D 44 01 20 CF	FE 09 58 42 48 43 4D 44 01 20 XX C		Video scaling: 16:9 > 4:3 > Point to Point > Automatic > 16:9 XX: 00: Fail 01: Success

## Peripheral Management

Description	Command Code	Response Code	Note	Return Code Description
Get OPS Power Status	FE 08 58 42 48 43 4D 44 02 13 CF	FE 09 58 42 48 43 4D 44 02 13 XX CF		XX: 00: Standby 01: Power on
Set OPS Power Status	FE 09 58 42 48 43 4D 44 03 13 XX CF	FE 0A 58 42 48 43 4D 44 03 13 XX YY CF		XX: 00: Standby 01: Power on YY: 00: Fail 01: Success

## Network Management

Description	Command Code	Response Code	Note	Return Code Description
Turn Wired Network On/Off	FE 09 58 42 48 43 4D 44 03 16 XX CF	FE 0A 58 42 48 43 4D 44 03 16 XX YY CF		XX: 00: Off 01: On YY: 00: Fail 01: Success
Get Wired Network Switch Status	FE 08 58 42 48 43 4D 44 02 16 CF	FE 09 58 42 48 43 4D 44 02 16 XX CF		XX: 00: Off 01: On
Turn Wireless Network On/Off	FE 09 58 42 48 43 4D 44 03 17 XX CF	FE 0A 58 42 48 43 4D 44 03 17 XX YY CF		XX: 00: Off 01: On YY: 00: Fail 01: Success
Get Wireless Network Switch Status	FE 08 58 42 48 43 4D 44 02 17 CF	FE 09 58 42 48 43 4D 44 02 17 XX CF		XX: 00: Off 01: On
WiFi-Hotspot Switch	FE 09 58 42 48 43 4D 44 03 18 XX CF	FE 0A 58 42 48 43 4D 44 03 18 XX YY CF		XX: 00: Off 01: On YY: 00: Fail 01: Success
Get WiFi-Hotspot Switch Status	FE 08 58 42 48 43 4D 44 02 18 CF	FE 09 58 42 48 43 4D 44 02 18 XX CF		XX: 00: Off 01: On
Get Wired MAC Address of Android System	FE 08 58 42 48 43 4D 44 02 09 CF	FE 0E 58 42 48 43 4D 44 02 09 X1 X2 X3 X4 X5 X6 CF		X1 → X6: MAC address of Android system X1:X2:X3:X4:X5:X6

## Touch Management

Description	Command Code	Response Code	Note	Return Code Description
Touch Lock	FE 09 58 42 48 43 4D 44 03 06 00 CF	FE 0A 58 42 48 43 4D 44 03 06 00 XX CF		XX: 00: Fail 01: Success
Touch Unlock	FE 09 58 42 48 43 4D 44 03 06 01 CF	FE 0A 58 42 48 43 4D 44 03 06 01 XX CF		XX: 00: Fail 01: Success
Get Touch Status	FE 08 58 42 48 43 4D 44 03 06 CF	FE 09 58 42 48 43 4D 44 03 06 XX CF		XX refers to touch state: 00: Touch Off 01: Touch On

# Appendix

## Specifications

Item	Category	Specifications	
Model	P/N.	IN6501	IN7501
	No.	VS20038	VS20039
Display	Display Size	65"	75"
	Active Size (H x V)	1,428.48 × 803.52 mm	1,649.664 × 927.936 mm
		56.24" x 31.63"	64.95" x 36.53"
	Surface Treatment	Anti-Glare (Haze 25%) Hard-Coating (9H)	
	Brightness	400 nits (Typical)	
Native Resolution	HDMI: 3840 x 2160 @ 60 Hz VGA: 1920 x 1080 @ 60 Hz		
Input Signal		3 x HDMI 2.0 (3840 x 2160 @ 60 Hz)	
		1 x VGA (1920 x 1080 @ 60 Hz)	
		1 x Audio (3.5 mm)	
		1 x RS-232	
Output Signal		1 x HDMI 2.0 (3840 x 2160 @ 60 Hz)	
		1 x Audio (3.5 mm)	
		1 x SPDIF	
USB	Type A	4 x USB 3.0	2 x USB 3.0
		1 x USB 2.0	2 x USB 2.0
	Type B	2 x USB 2.0	
	Type C	1 x USB 2.0	
Network	LAN	10M/100M	
	Wireless	Built-in Wi-Fi 5 & Bluetooth 5.0	
PC Slot		1 x 80-pin OPS (18V/3.5A)	
Audio	Speakers	2 x 20W (Rated 16W, Peak 20W)	
RS-232		RS-232 Communication	
Power	Voltage	100~240V +/- 10% 50/60 Hz	
Operating Conditions	Altitude	3,000 m	
		9,842.52 ft	
	Relative Humidity	10%~80% (non-condensing)	
	Temperature	0° C~40° C	
32° F~104° F			

Item	Category	Specifications	
Storage Conditions	Altitude	2,500 m	
		8,202.1 ft	
	Relative Humidity	0%~93% (non-condensing)	
	Temperature	-25° C~55° C	
-13° F~131° F			
Dimensions	Physical (W x H x D)	1,493.4 x 898.5 x 93.7 mm	1,715.6 x 1,021.9 x 93.7 mm
		58.80" x 35.37" x 3.69"	67.54" x 40.23" x 3.69"
Weight	Physical	34.7 kg	46.0 kg
		76.5 lbs	101.4 lbs
Power Consumption	On	190W (Normal) 320W (Maximum)	245W (Normal) 385W (Maximum)
	Off	< 0.5W	

**NOTE:** Product specifications are subject to change without notice.

# Resolution and Timings

## HDMI

Resolution	Refresh Rate (@)
640 x 480	60, 75 Hz
720 x 400	70 Hz
720 x 480	60 Hz
720 x 756	50 Hz
800 x 600	60, 75 Hz
1024 x 768	60 Hz
1280 x 720	24, 25, 30, 50, 60 Hz
1920 x 1080	24, 25, 30, 50, 60 Hz
3840 x 2160	24, 25, 30, 50, 60 Hz

## VGA

Resolution	Refresh Rate (@)
640 x 480	60, 72, 75 Hz
800 x 600	60, 72, 75 Hz
832 x 624	75 Hz
1024 x 768	60 Hz
1152 x 870	75 Hz
1280 x 960	60 Hz
1280 x 1024	60, 75 Hz
1920 x 1080	60 Hz

## Troubleshooting

This section describes some common problems that you may experience when using the ViewBoard.

Problem or Issue	Possible Solutions
Remote Control is not working	<ol style="list-style-type: none"><li>1. Check whether something is obstructing the display's remote control receiver.</li><li>2. Check whether the batteries in the remote control are installed correctly.</li><li>3. Check whether the batteries need to be replaced.</li></ol>
The unit turns off unexpectedly	<ol style="list-style-type: none"><li>1. Check whether Sleep mode is enabled.</li><li>2. Check if there is a power outage in your area.</li><li>3. Turn on the display and see if the problem is with the signal and control system.</li></ol>

## PC Mode

Problem or Issue	Possible Solutions
No PC signal	<ol style="list-style-type: none"><li>1. Check the display settings.</li><li>2. Check the display resolution.</li><li>3. Adjust the Hs &amp; Vs (synchronization) settings using the OSD menu.</li></ol>
Background streaking	<ol style="list-style-type: none"><li>1. Choose auto adjust.</li><li>2. Adjust clock and phase.</li></ol>
Unsupported format	<ol style="list-style-type: none"><li>1. Choose auto adjust.</li><li>2. Adjust clock and phase settings.</li></ol>

## Touch Function

Problem or Issue	Possible Solutions
Touch function does not work	<ol style="list-style-type: none"><li>1. Check that drivers are installed correctly.</li><li>2. Reinstall driver(s).</li><li>3. Check setup and align it.</li><li>4. Check whether the touch pen is working properly.</li></ol>

## Video Not Working Properly

Problem or Issue	Possible Solutions
No picture/ No sound	<ol style="list-style-type: none"><li>1. Check the Power status.</li><li>2. Check the signal cable.</li><li>3. Check that the internal PC is installed correctly.</li></ol>
Picture is unclear or cuts in and out	<ol style="list-style-type: none"><li>1. Check the signal cable.</li><li>2. Check if other electronics are interrupting the signal.</li></ol>
Poor picture	<ol style="list-style-type: none"><li>1. Adjust chroma, brightness, and contrast settings in the menu.</li><li>2. Check the signal cable.</li></ol>

## Audio Not Working Properly

Problem or Issue	Possible Solutions
No sound	<ol style="list-style-type: none"><li>1. Press the Mute/Unmute button.</li><li>2. Adjust the volume.</li><li>3. Check the audio cable.</li></ol>
One speaker only	<ol style="list-style-type: none"><li>1. Adjust the sound balance in the menu.</li><li>2. Check the sound control panel settings of the computer.</li><li>3. Check the audio cable.</li></ol>

# Maintenance

## General Precautions

- Make sure the device is turned off and the power cable is unplugged from the power outlet.
- Never spray or pour any liquid directly onto the screen or case.
- Handle the device with care, as a darker-colored device, if scuffed, may show marks more clearly than a lighter-colored device.
- Do not use the system continuously for long periods of time.

## Cleaning the Screen

- Wipe the screen with a clean, soft, lint-free cloth. This removes dust and other particles.
- If the screen is still not clean, apply a small amount of non-ammonia, non-alcohol based glass cleaner onto a clean, soft, lint-free cloth; then wipe the screen.

## Cleaning the Case

- Use a soft, dry cloth.
- If the case is still not clean, apply a small amount of non-ammonia, non-alcohol based, mild non-abrasive detergent onto a clean, soft, lint-free cloth, then wipe the surface.

## Disclaimer

- ViewSonic® does not recommend the use of any ammonia or alcohol-based cleaners on the display screen or case. Some chemical cleaners have been reported to damage the screen and/or case of the device.
- ViewSonic® will not be liable for damage resulting from use of any ammonia or alcohol-based cleaners.

**NOTE:** If condensation appears between the glass and the panel, keep the display turned on until the moisture disappears.

# Regulatory and Service Information

## Compliance Information

This section addresses all connected requirements and statements regarding regulations. Confirmed corresponding applications shall refer to nameplate labels and relevant markings on the unit.

### Declaration of RoHS2 Compliance

This product has been designed and manufactured in compliance with Directive 2011/65/EU of the European Parliament and the Council on restriction of the use of certain hazardous substances in electrical and electronic equipment (RoHS2 Directive) and is deemed to comply with the maximum concentration values issued by the European Technical Adaptation Committee (TAC) as shown below:

Substance	Proposed Maximum Concentration	Actual Concentration
Lead (Pb)	0.1%	< 0.1%
Mercury (Hg)	0.1%	< 0.1%
Cadmium (Cd)	0.01%	< 0.01%
Hexavalent Chromium (Cr6 <sup>+</sup> )	0.1%	< 0.1%
Polybrominated biphenyls (PBB)	0.1%	< 0.1%
Polybrominated diphenyl ethers (PBDE)	0.1%	< 0.1%
Bis (2-ethylhexyl) phthalate (DEHP)	0.1%	< 0.1%
Butyl benzyl phthalate (BBP)	0.1%	< 0.1%
Dibutyl phthalate (DBP)	0.1%	< 0.1%
Diisobutyl phthalate (DIBP)	0.1%	< 0.1%

**Certain components of products as stated above are exempted under the Annex III of the RoHS2 Directives as noted below:**

- Copper alloy containing up to 4% lead by weight.
- Lead in high melting temperature type solders (i.e. lead-based alloys containing 85% by weight or more lead).
- Electrical and electronic components containing lead in a glass or ceramic other than dielectric ceramic in capacitors, e.g. piezoelectronic devices, or in a glass or ceramic matrix compound.
- Lead in dielectric ceramic in capacitors for a rated voltage of 125V AC or 250V DC or higher.

## Indian Restriction of Hazardous Substances

Restriction on Hazardous Substances statement (India). This product complies with the “India E-waste Rule 2011” and prohibits use of lead, mercury, hexavalent chromium, polybrominated biphenyls or polybrominated diphenyl ethers in concentrations exceeding 0.1 weight % and 0.01 weight % for cadmium, except for the exemptions set in Schedule 2 of the Rule.

## Product Disposal at End of Product Life

ViewSonic® respects the environment and is committed to working and living green. Thank you for being part of Smarter, Greener Computing. Please visit the ViewSonic® website to learn more.

### USA & Canada:

<https://www.viewsonic.com/us/go-green-with-viewsonic>

### Europe:

<https://www.viewsonic.com/eu/environmental-social-governance/recycle>

### Taiwan:

<https://recycle.moenv.gov.tw/>

**For EU users, please contact us for any safety/accident issue experienced with this product:**

ViewSonic Europe Limited



Haaksbergweg 75  
1101 BR Amsterdam  
Netherlands



+31 (0) 650608655



[EPREL@viewsoniceurope.com](mailto:EPREL@viewsoniceurope.com)



<https://www.viewsonic.com/eu/>

## Copyright Information

Copyright© ViewSonic® Corporation, 2024. All rights reserved.

Macintosh and Power Macintosh are registered trademarks of Apple Inc.

Microsoft, Windows, and the Windows logo are registered trademarks of Microsoft Corporation in the United States and other countries.

ViewSonic® and the three birds logo are registered trademarks of ViewSonic® Corporation.

VESA is a registered trademark of the Video Electronics Standards Association. DPMS, DisplayPort, and DDC are trademarks of VESA.

ENERGY STAR® is a registered trademark of the U.S. Environmental Protection Agency (EPA).

As an ENERGY STAR® partner, ViewSonic® Corporation has determined that this product meets the ENERGY STAR® guidelines for energy efficiency.

**Disclaimer:** ViewSonic® Corporation shall not be liable for technical or editorial errors or omissions contained herein; nor for incidental or consequential damages resulting from furnishing this material, or the performance or use of this product.

In the interest of continuing product improvement, ViewSonic® Corporation reserves the right to change product specifications without notice. Information in this document may change without notice.

No part of this document may be copied, reproduced, or transmitted by any means, for any purpose without prior written permission from ViewSonic® Corporation.

## Customer Service

For technical support or product service, see the table below or contact your reseller.

**NOTE:** You will need the product's serial number.

Country/ Region	Website	Country/ Region	Website
<b>Asia Pacific &amp; Africa</b>			
Australia	<a href="http://www.viewsonic.com/au/">www.viewsonic.com/au/</a>	Bangladesh	<a href="http://www.viewsonic.com/bd/">www.viewsonic.com/bd/</a>
中国 (China)	<a href="http://www.viewsonic.com.cn">www.viewsonic.com.cn</a>	香港 (繁體中文)	<a href="http://www.viewsonic.com/hk/">www.viewsonic.com/hk/</a>
Hong Kong (English)	<a href="http://www.viewsonic.com/hk-en/">www.viewsonic.com/hk-en/</a>	India	<a href="http://www.viewsonic.com/in/">www.viewsonic.com/in/</a>
Indonesia	<a href="http://www.viewsonic.com/id/">www.viewsonic.com/id/</a>	Israel	<a href="http://www.viewsonic.com/il/">www.viewsonic.com/il/</a>
日本 (Japan)	<a href="http://www.viewsonic.com/jp/">www.viewsonic.com/jp/</a>	Korea	<a href="http://www.viewsonic.com/kr/">www.viewsonic.com/kr/</a>
Malaysia	<a href="http://www.viewsonic.com/my/">www.viewsonic.com/my/</a>	Middle East	<a href="http://www.viewsonic.com/me/">www.viewsonic.com/me/</a>
Myanmar	<a href="http://www.viewsonic.com/mm/">www.viewsonic.com/mm/</a>	Nepal	<a href="http://www.viewsonic.com/np/">www.viewsonic.com/np/</a>
New Zealand	<a href="http://www.viewsonic.com/nz/">www.viewsonic.com/nz/</a>	Pakistan	<a href="http://www.viewsonic.com/pk/">www.viewsonic.com/pk/</a>
Philippines	<a href="http://www.viewsonic.com/ph/">www.viewsonic.com/ph/</a>	Singapore	<a href="http://www.viewsonic.com/sg/">www.viewsonic.com/sg/</a>
臺灣 (Taiwan)	<a href="http://www.viewsonic.com/tw/">www.viewsonic.com/tw/</a>	ประเทศไทย	<a href="http://www.viewsonic.com/th/">www.viewsonic.com/th/</a>
Việt Nam	<a href="http://www.viewsonic.com/vn/">www.viewsonic.com/vn/</a>	South Africa & Mauritius	<a href="http://www.viewsonic.com/za/">www.viewsonic.com/za/</a>
<b>Americas</b>			
United States	<a href="http://www.viewsonic.com/us">www.viewsonic.com/us</a>	Canada	<a href="http://www.viewsonic.com/us">www.viewsonic.com/us</a>
Latin America	<a href="http://www.viewsonic.com/la">www.viewsonic.com/la</a>		
<b>Europe</b>			
Europe	<a href="http://www.viewsonic.com/eu/">www.viewsonic.com/eu/</a>	France	<a href="http://www.viewsonic.com/fr/">www.viewsonic.com/fr/</a>
Deutschland	<a href="http://www.viewsonic.com/de/">www.viewsonic.com/de/</a>	Қазақстан	<a href="http://www.viewsonic.com/kz/">www.viewsonic.com/kz/</a>
Россия	<a href="http://www.viewsonic.com/ru/">www.viewsonic.com/ru/</a>	España	<a href="http://www.viewsonic.com/es/">www.viewsonic.com/es/</a>
Türkiye	<a href="http://www.viewsonic.com/tr/">www.viewsonic.com/tr/</a>	Україна	<a href="http://www.viewsonic.com/ua/">www.viewsonic.com/ua/</a>
United Kingdom	<a href="http://www.viewsonic.com/uk/">www.viewsonic.com/uk/</a>		

## Limited Warranty

### ViewSonic® Smart White Board

#### What the warranty covers:

ViewSonic® warrants its products to be free from defects in material and workmanship during the warranty period. If a product proves to be defective in material or workmanship during the warranty period, ViewSonic® will, at its sole option, and as your sole remedy, repair or replace the product with a similar product. Replacement Product or parts may include remanufactured or refurbished parts or components. The repair or replacement unit or parts or components will be covered by the balance of the time remaining on the customer's original limited warranty and the warranty period will not be extended. ViewSonic® provides no warranty for any third-party software whether included with the product or installed by the customer, installation of any unauthorized hardware parts or components (e.g. Projector Lamps). (Please refer to: "What the warranty excludes and does not cover" section).

#### Who the warranty protects:

This warranty is valid only for the first consumer purchaser.

#### What the warranty excludes and does not cover:

- Any product on which the serial number has been defaced, modified, or removed.
- Damage, deterioration, or malfunction resulting from:
  - » Accident, misuse, neglect, fire, water, lightning, or other acts of nature, unauthorized product modification, or failure to follow instructions supplied with the product.
  - » Repair or attempted repair by anyone not authorized by ViewSonic®.
  - » Damage to or loss of any programs, data, or removable storage media.
  - » Normal wear and tear.
  - » Removal or installation of the product.
- Software or data loss occurring during repair or replacement.
- Any damage of the product due to shipment.
- Causes external to the product, such as electric power fluctuations or failure.
- Use of supplies or parts not meeting ViewSonic's specifications.
- Failure of owner to perform periodic product maintenance as stated in the User Guide.

- Any other cause which does not relate to a product defect.
- Damage caused by static (non-moving) images displayed for lengthy periods of time (also referred to as image burn-in).
- Software - Any third-party software included with the product or installed by the customer.
- Hardware/Accessories/Parts/Components – Installation of any unauthorized hardware, accessories, consumable parts or components (e.g. Projector Lamps).
- Damage to, or abuse of, the coating on the surface of the display through inappropriate cleaning as described in the product User Guide.
- Removal, installation, and set-up service charges, including wall-mounting of the product.

### **How to get service:**

- For information about receiving service under warranty, contact ViewSonic® Customer Support (Please refer to the “Customer Service” page). You will need to provide your product’s serial number.
- To obtain warranty service, you will be required to provide: (a) the original dated sales slip, (b) your name, (c) your address, (d) a description of the problem, and (e) the serial number of the product.
- Take or ship the product, freight prepaid, in the original container to an authorized ViewSonic® service center or ViewSonic®.
- For additional information or the name of the nearest ViewSonic® service center, contact ViewSonic®.

### **Limitation of implied warranties:**

There are no warranties, express or implied, which extend beyond the description contained herein including the implied warranty of merchantability and fitness for a particular purpose.

**Exclusion of damages:**

ViewSonic's liability is limited to the cost of repair or replacement of the product. ViewSonic® shall not be liable for:

- Damage to other property caused by any defects in the product, damages based upon inconvenience, loss of use of the product, loss of time, loss of profits, loss of business opportunity, loss of goodwill, interference with business relationships, or other commercial loss, even if advised of the possibility of such damages.
- Any other damages, whether incidental, consequential or otherwise.
- Any claim against the customer by any other party.
- Repair or attempted repair by anyone not authorized by ViewSonic®.

**Effect of state law:**

This warranty gives you specific legal rights, and you may also have other rights which vary from state to state. Some states do not allow limitations on implied warranties and/or do not allow the exclusion of incidental or consequential damages, so the above limitations and exclusions may not apply to you.

**Sales outside the U.S.A. and Canada:**

For warranty information and service on ViewSonic® products sold outside of the U.S.A. and Canada, contact ViewSonic® or your local ViewSonic® dealer.

The warranty period for this product in mainland China (Hong Kong, Macao, and Taiwan Excluded) is subject to the terms and conditions of the Maintenance Guarantee Card.

For users in Europe and Russia, full details of warranty provided can be found at: <http://www.viewsonic.com/eu/> under "Support/Warranty Information".

## **Mexico Limited Warranty**

### ViewSonic® Smart White Board

#### **What the warranty covers:**

ViewSonic® warrants its products to be free from defects in material and workmanship, under normal use, during the warranty period. If a product proves to be defective in material or workmanship during the warranty period, ViewSonic® will, at its sole option, repair or replace the product with a like product. Replacement product or parts may include remanufactured or refurbished parts or components & accessories.

#### **Who the warranty protects:**

This warranty is valid only for the first consumer purchaser.

#### **What the warranty excludes and does not cover:**

- Any product on which the serial number has been defaced, modified or removed.
- Damage, deterioration, or malfunction resulting from:
  - » Accident, misuse, neglect, fire, water, lightning, or other acts of nature, unauthorized product modification, unauthorized attempted repair, or failure to follow instructions supplied with the product.
  - » Causes external to the product, such as electrical power fluctuations or failure.
  - » Use of supplies or parts not meeting ViewSonic®'s specifications.
  - » Normal wear and tear.
  - » Any other cause which does not relate to a product defect.
- Any product exhibiting a condition commonly known as “image burn-in” which results when a static image is displayed on the product for an extended period of time.
- Removal, installation, insurance, and set-up service charges.

**How to get service:**

For information about receiving service under warranty, contact ViewSonic® Customer Support (Please refer to the attached “Customer Service” page). You will need to provide your product’s serial number, so please record the product information in the space provided below on your purchase for your future use. Please retain your receipt of proof of purchase to support your warranty claim.

**For Your Records**

Product Name: \_\_\_\_\_ Model Number: \_\_\_\_\_  
Document Number: \_\_\_\_\_ Serial Number: \_\_\_\_\_  
Purchase Date: \_\_\_\_\_ Extended Warranty Purchase? \_\_\_\_\_(Y/N)  
If so, what date does warranty expire? \_\_\_\_\_

- To obtain warranty service, you will be required to provide (a) the original dated sales slip, (b) your name, (c) your address, (d) a description of the problem, and (e) the serial number of the product.
- Take or ship the product, in the original container packaging, to an authorized ViewSonic® service center.
- Round trip transportation costs for in-warranty products will be paid by ViewSonic®.

**Limitation of implied warranties:**

There are no warranties, express or implied, which extend beyond the description contained herein including the implied warranty of merchantability and fitness for a particular purpose.

**Exclusion of damages:**

ViewSonic®’s liability is limited to the cost of repair or replacement of the product. ViewSonic® shall not be liable for:

- Damage to other property caused by any defects in the product, damages based upon inconvenience, loss of use of the product, loss of time, loss of profits, loss of business opportunity, loss of goodwill, interference with business relationships, or other commercial loss, even if advised of the possibility of such damages.
- Any other damages, whether incidental, consequential or otherwise.
- Any claim against the customer by any other party.
- Repair or attempted repair by anyone not authorized by ViewSonic®.

Contact Information for Sales & Authorized Service (Centro Autorizado de Servicio) within Mexico:	
<b>Name, address, of manufacturer and importers:</b> México, Av. de la Palma #8 Piso 2 Despacho 203, Corporativo Interpalmas, Col. San Fernando Huixquilucan, Estado de México Tel: (55) 3605-1099 <a href="http://www.viewsonic.com/la/soporte/index.htm">http://www.viewsonic.com/la/soporte/index.htm</a>	
NÚMERO GRATIS DE ASISTENCIA TÉCNICA PARA TODO MÉXICO: 001.866.823.2004	
<b>Hermosillo:</b> Distribuciones y Servicios Computacionales SA de CV. Calle Juarez 284 local 2 Col. Bugambilias C.P: 83140 Tel: 01-66-22-14-9005 E-Mail: <a href="mailto:disc2@hmo.megared.net.mx">disc2@hmo.megared.net.mx</a>	<b>Villahermosa:</b> Compumantenimientos Garantizados, S.A. de C.V. AV. GREGORIO MENDEZ #1504 COL, FLORIDA C.P. 86040 Tel: 01 (993) 3 52 00 47 / 3522074 / 3 52 20 09 E-Mail: <a href="mailto:compumantenimientos@prodigy.net.mx">compumantenimientos@prodigy.net.mx</a>
<b>Puebla, Pue. (Matriz):</b> RENTA Y DATOS, S.A. DE C.V. Domicilio: 29 SUR 721 COL. LA PAZ 72160 PUEBLA, PUE. Tel: 01(52).222.891.55.77 CON 10 LINEAS E-Mail: <a href="mailto:datos@puebla.megared.net.mx">datos@puebla.megared.net.mx</a>	<b>Veracruz, Ver.:</b> CONEXION Y DESARROLLO, S.A DE C.V. Av. Americas # 419 ENTRE PINZÓN Y ALVARADO Fracc. Reforma C.P. 91919 Tel: 01-22-91-00-31-67 E-Mail: <a href="mailto:gacosta@qplus.com.mx">gacosta@qplus.com.mx</a>
<b>Chihuahua:</b> Soluciones Globales en Computación C. Magisterio # 3321 Col. Magisterial Chihuahua, Chih. Tel: 4136954 E-Mail: <a href="mailto:Cefeo@soluglobales.com">Cefeo@soluglobales.com</a>	<b>Cuernavaca:</b> Compusupport de Cuernavaca SA de CV Francisco Leyva # 178 Col. Miguel Hidalgo C.P. 62040, Cuernavaca Morelos Tel: 01 777 3180579 / 01 777 3124014 E-Mail: <a href="mailto:aquevedo@compusupportcva.com">aquevedo@compusupportcva.com</a>
<b>Distrito Federal:</b> QPLUS, S.A. de C.V. Av. Coyoacán 931 Col. Del Valle 03100, México, D.F. Tel: 01(52)55-50-00-27-35 E-Mail : <a href="mailto:gacosta@qplus.com.mx">gacosta@qplus.com.mx</a>	<b>Guadalajara, Jal.:</b> SERVICRECE, S.A. de C.V. Av. Niños Héroes # 2281 Col. Arcos Sur, Sector Juárez 44170, Guadalajara, Jalisco Tel: 01(52)33-36-15-15-43 E-Mail: <a href="mailto:mmiranda@servicrece.com">mmiranda@servicrece.com</a>
<b>Guerrero Acapulco:</b> GS Computación (Grupo Sesicomp) Progreso #6-A, Colo Centro 39300 Acapulco, Guerrero Tel: 744-48-32627	<b>Monterrey:</b> Global Product Services Mar Caribe # 1987, Esquina con Golfo Pérsico Fracc. Bernardo Reyes, CP 64280 Monterrey N.L. México Tel: 8129-5103 E-Mail: <a href="mailto:aydeem@gps1.com.mx">aydeem@gps1.com.mx</a>
<b>MERIDA:</b> ELECTROSER Av Reforma No. 403Gx39 y 41 Mérida, Yucatán, México CP97000 Tel: (52) 999-925-1916 E-Mail: <a href="mailto:rrrb@sureste.com">rrrb@sureste.com</a>	<b>Oaxaca, Oax.:</b> CENTRO DE DISTRIBUCION Y SERVICIO, S.A. de C.V. Murguía # 708 P.A., Col. Centro, 68000, Oaxaca Tel: 01(52)95-15-15-22-22 Fax: 01(52)95-15-13-67-00 E-Mail: <a href="mailto:gpotai2001@hotmail.com">gpotai2001@hotmail.com</a>
<b>Tijuana:</b> STD Av Ferrocarril Sonora #3780 L-C Col 20 de Noviembr Tijuana, Mexico	<b>FOR USA SUPPORT:</b> ViewSonic® Corporation 381 Brea Canyon Road, Walnut, CA. 91789 USA Tel: 800-688-6688 E-Mail: <a href="http://www.viewsonic.com">http://www.viewsonic.com</a>



**ViewSonic®**